

ATTENTION:
In order to drill handle holes precisely and quickly, we recommend using our drill jig

index 20173

Important dimension

for handles: 10-ka
Fox
Vitara

A = 24 mm, B = 21 mm

for handles: Gemini
Julia
Karat
Lynx
Romeo

A = 17 mm, B = 14 mm

COMPONENTS

Handle L: 2,70 m					Lower horizontal profile Decor 10 (A)	
					Upper horizontal profile Decor 10 (B) 	
Guiding carriage		Bottom carriage WD10C HI-TEC	Top track Gemini-Decor	Bottom track Gemini-Decor II		
10-ka or GEMINI			L: 1,70 m, 2,35 m 3,00 m, 4,05 m 6,00 m 76 mm	L: 1,70 m, 2,35 m 3,00 m, 4,05 m 6,00 m 53 mm		

You must remember to purchase self-tapping screws to construct each door (4 screws per door). When using safety glass, you must also remember to purchase gaskets.

With Gemini 10 set you may use bottom track **Elegant II** with covering strip along with bottom carriage **WD 10V HI-TEC**. Fitting measurements are not affected.

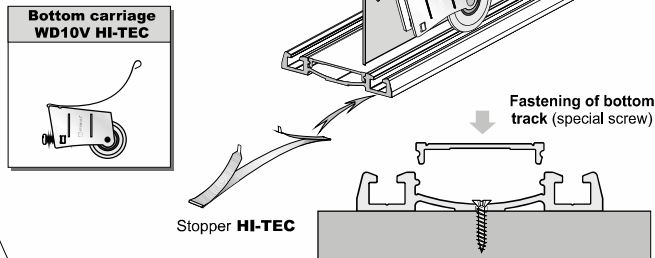

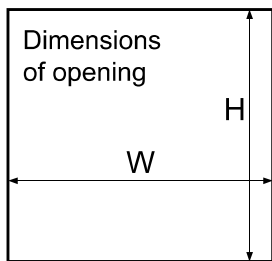

		Handle length = door height											
		LINE 10-ka				LINE FOX				LINE VITARA			
		Handle 10-ka II		Guiding carriage 10-ka		Handle Fox II		Guiding carriage 10-ka		Handle Vitara		Guiding carriage 10-ka	
Dimensions of opening		anti-dust brush (inserted) 4.8 mm x 13 mm				anti-dust brush (inserted) 4.8 mm x 13 mm				anti-dust brush (inserted) 4.8 mm x 13 mm			
textile door stop (inserted) 14 mm x 4 mm													
door height	- h	h = H - 40 mm				h = H - 40 mm				h = H - 40 mm			
door wing height with soft-close fitted		Mini SV25/40/60 SV-25/50	h = H - 40 mm		Mini SV25/40/60 SV-25/50	h = H - 40 mm		Mini SV25/40/60 SV-25/50	h = H - 40 mm		Mini SV25/40/60 SV-25/50	h = H - 40 mm	
		Top SV60/80, Central SV25/40	h = H - 44 mm		Top SV60/80, Central SV25/40	h = H - 44 mm		Top SV60/80, Central SV25/40	h = H - 44 mm		Top SV60/80, Central SV25/40	h = H - 44 mm	
board height	- hb	hb = h - 64 mm				hb = h - 64 mm				hb = h - 64 mm			
door width	- w	w = (W - 3 mm + Z) : N				w = (W - 3 mm + Z) : N				w = (W - 3 mm + Z) : N			
board width	- wb	wb = w - 36 mm				wb = w - 20 mm				wb = w - 20 mm			
lower horizontal profile length - L		L = U = w - 53 mm				L = U = w - 37 mm				L = U = w - 36 mm			
upper horizontal profile length - U													
mirror height	- hm	hm = hb				hm = hb				hm = hb			
mirror width	- wm	wm = wb - 4 mm				wm = wb - 4 mm				wm = wb - 4 mm			

number of doors	- N	2	3	4	5	2	3	4	5	2	3	4	5
total overlap	- Z	35 mm	70 mm	105 mm	140 mm	36 mm	72 mm	108 mm	144 mm	20 mm	39 mm	59 mm	78 mm

visual design – 4 wings			
	$w = (W - 3 + 105) : 4$	$w = (W - 3 + 108) : 4$	$w = (W - 3 + 59) : 4$
	$w = (W : 2 + 32) : 2$	$w = (W : 2 + 33) : 2$	$w = (W : 2 + 17) : 2$

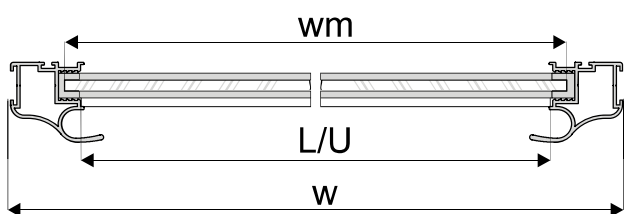
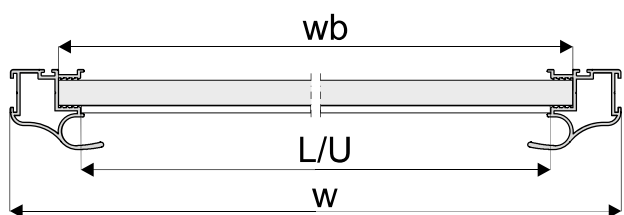

Installation method for fitting 10 mm board (diag. A) and 4 mm mirror or glass (diag. B)

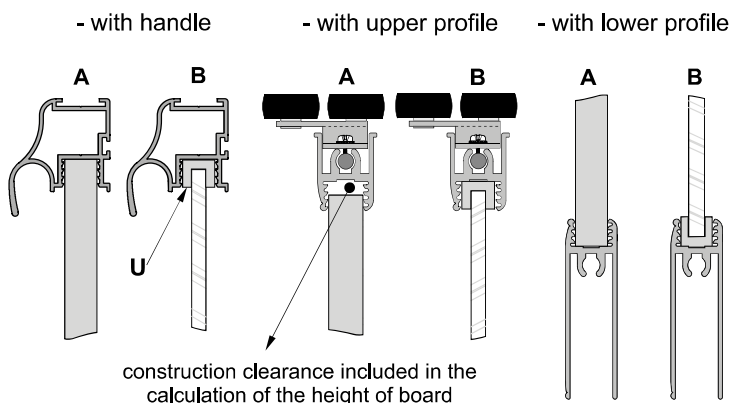





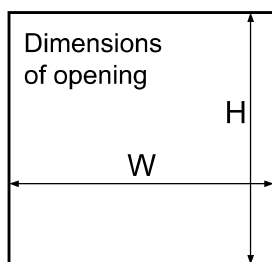

construction clearance included in the calculation of the height of board

ATTENTION!

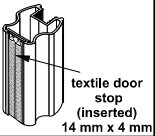
Mirror (4 mm) should be used with a safety backing film. Safety glass (4.5 mm) comprises of two thin layers with a film in-between. Both mirror and glass need fitting gaskets U.

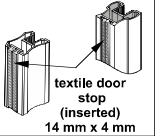

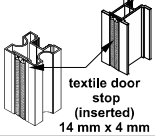
Handle length = door height

	LINE GEMINI		LINE JULIA/ROMEO		LINE KARAT/LYNX							
	Handle Gemini-Decor  textile door stop (inserted) 14 mm x 4 mm	Guiding carriage Gemini  L/P	Handle Julia II Handle Romeo II  textile door stop (inserted) 14 mm x 4 mm	Guiding carriage Gemini  L/P	Handle Karat Handle Lynx  textile door stop (inserted) 14 mm x 4 mm	Guiding carriage Gemini  L/P						
door height - h	h = H - 40 mm		h = H - 40 mm		h = H - 40 mm							
door wing height with soft-close fitted	Mini SV25/40/60 SV-25/50	h = H - 40 mm	Mini SV25/40/60 SV-25/50	h = H - 40 mm	Mini SV25/40/60 SV-25/50	h = H - 40 mm						
	Top SV60/80, Central SV25/40	h = H - 44 mm	Top SV60/80, Central SV25/40	h = H - 44 mm	Top SV60/80, Central SV25/40	h = H - 44 mm						
board height - hb	hb = h - 64 mm		hb = h - 64 mm		hb = h - 64 mm							
door width - w	w = (W - 3 mm + Z) : N		w = (W - 3 mm + Z) : N		w = (W - 3 mm + Z) : N							
board width - wb	wb = w - 46 mm		wb = w - 25 mm		wb = w - 41 mm							
lower horizontal profile length - L	L = U = w - 62 mm		L = U = w - 42 mm		L = U = w - 58 mm							
upper horizontal profile length - U												
mirror height - hm	hm = hb		hm = hb		hm = hb							
mirror width - wm	wm = wb - 4 mm		wm = wb - 4 mm		wm = wb - 4 mm							
number of doors - N	2	3	4	5	2	3	4	5				
total overlap - Z	32 mm	64 mm	96 mm	128 mm	22 mm	44 mm	66 mm	88 mm	30 mm	60 mm	90 mm	120 mm

visual design – 4 wings

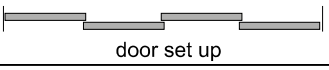
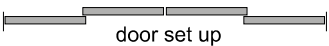
	$w = (W - 3 + 96) : 4$	$w = (W - 3 + 66) : 4$	$w = (W - 3 + 90) : 4$
	$w = (W : 2 + 29) : 2$	$w = (W : 2 + 19) : 2$	$w = (W : 2 + 27) : 2$

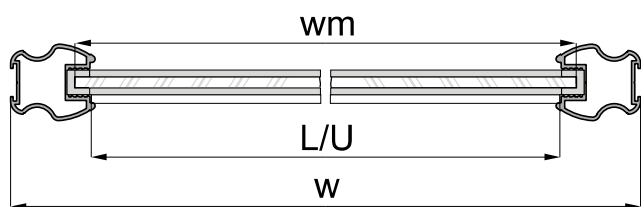
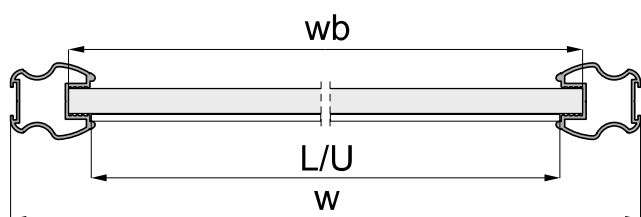

Installation method for fitting 10 mm board (diag. A) and 4 mm mirror or glass (diag. B)

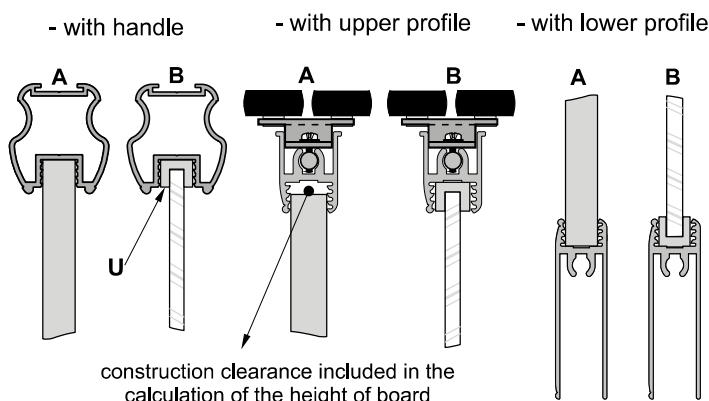
**ATTENTION!**

Mirror (4 mm) should be used with a safety backing film. Safety glass (4.5 mm) comprises of two thin layers with a film in-between. Both mirror and glass need fitting gaskets U.

