

# CONERO

## Inside Pullout 168 H 475

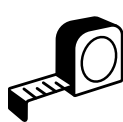

<http://support.kesseboehmer.de>

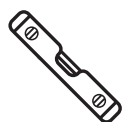
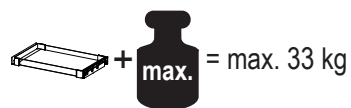
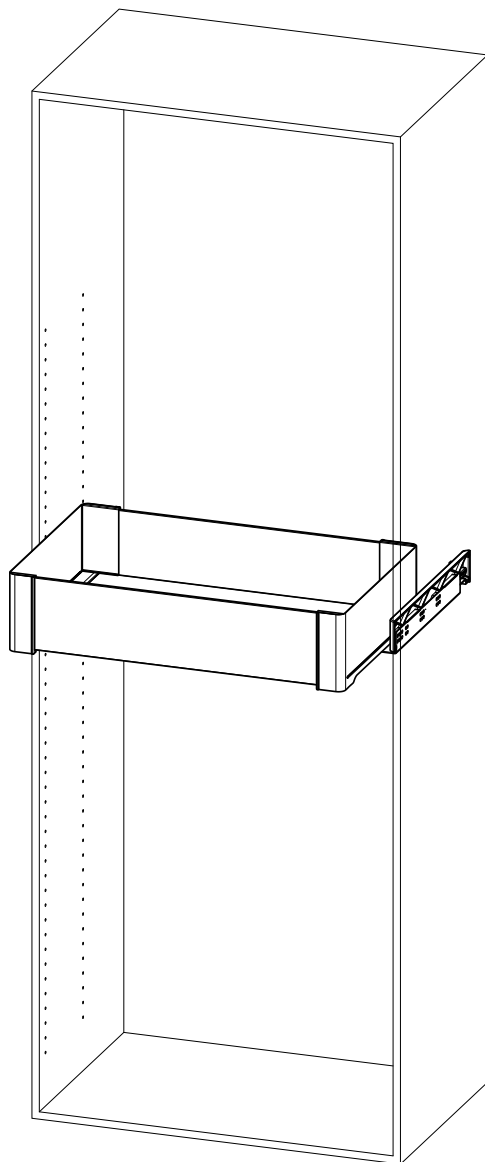
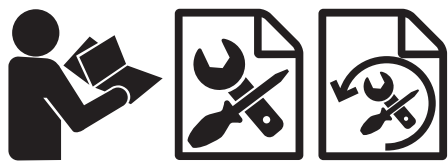

# CONERO

## Inside Pullout 168 H 475

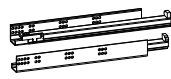

1x

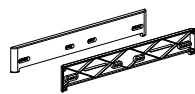

1x

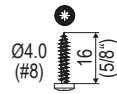

8x

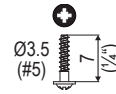

6x

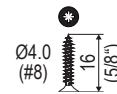

10x

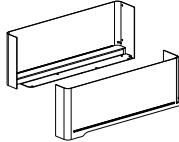

1x



1x



1x



4x

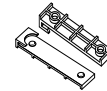

8x



1x

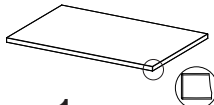
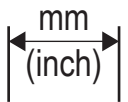

1x

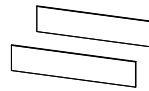

1x



optional

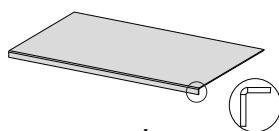

1x

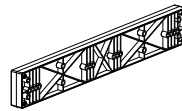

1x - 4x

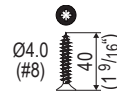

5x - 10x

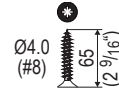

7x - 14x

**DE** Die technischen Darstellungen und Maßangaben – auch bei Abbildungen und Zeichnungen – sind unverbindlich. Konstruktionsverbesserungen sind vorbehalten! **EN** Technical information and stated dimensions (including in illustrations and drawings) must not be regarded as binding. Design subject to improvement without notice! **FR** Les visuels techniques et dimensions – y compris les schémas et les illustrations – ne sont pas contractuelles. Sous réserve d'évolutions techniques! **IT** Le rappresentazioni tecniche e le indicazioni delle dimensioni – anche nelle figure e nei disegni – non sono vincolanti. Con riserva di miglioramenti di progettazione! **ES** Las imágenes técnicas y las indicaciones de medidas – también en imágenes y dibujos – no son vinculantes. Queda reservado el derecho de realizar mejoras en el diseño! **PT** Representações técnicas e dimensões – mesmo em ilustrações e desenhos – não são vinculativas. Reservado o direito a melhorias construtivas! **HE** כל התרשימים הטכניים והמידות - אף לגבי איורים ותכניות - הנם בלתי מחייבים. זכות לשנויים ושיפורים מבניים שמורה ליצרן! **FI** Tekniset piirroksset ja mitat – myös kuvissa ja piirroksissa olevat – ovat sitoumuksetta. Oikeus rakennetta parantaviin muutoksiin pidätetään! **DA** De tekniske illustrationer og målangivelser - også på illustrationer og tegninger - er ikke bindende. Forbehold for designforbedringer! **CS** Technické popisy a rozměry, jakož i obrázky a výkresy, jsou nezávazné. Vyhradujeme si právo na změny konstrukce! **PL** Prezentacje techniczne i wymiary – także na ilustracjach i rysunkach – nie są wiążące. Udoskonalenia konstrukcyjne są zastrzeżone! **RU** Иллюстрации технических деталей и указанные размеры, в том числе на рисунках и чертежах, являются ориентировочными. Компания оставляет за собой право на усовершенствование конструкции! **TR** Teknik sunum ve ölçü bilgileri (resim ve çizimlerde de) yasal olarak bağlayıcı değildir. Yapısal geliştirmeler uyarı hakkı saklıdır! **BG** Техническото представяне и размерите, включително при изображенията и чертежите, са необвързващи. Запазваме си правото на конструктивни подобрения! **HU** A műszaki ábrázolások és méretadatok – ábránál és rajzoknál sem – nem kötelező érvényűek. A konstrukciós javítások joga fenntartva! **SR** Tehničke ilustracije i dimenzije - uključujući ilustracije i crteže - nisu obavezujući. Dizajn poboljšanja su rezervisana! **EL** Τα τεχνικά σχήματα και οι διαστάσεις – ακόμα και σε απεικονίσεις και σχέδια – δεν είναι δεσμευτικά. Με την επιφύλαξη τεχνικών βελτιώσεων! **AR** الرسوم التوضيحية والأبعاد الفنية - بما في ذلك الرسوم التوضيحية والرسومات - ليست إلزامية. الحق محفوظ في إجراء تحسينات هيكلية! **JA** 技術情報および記載されている寸法(イラストや図面を含む)は、拘束的のあるものと見なされません。デザインは予告なしに改善されることがあります。 **CN** 技术说明和规格, 包括插图和图纸均不具约束力。保留改进设计的权利!

# CONERO

## Inside Pullout 168 H 475



1

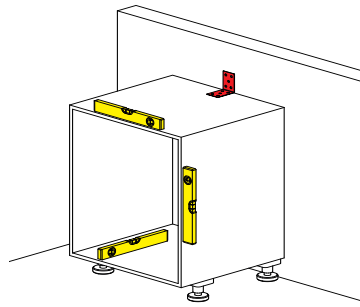

1

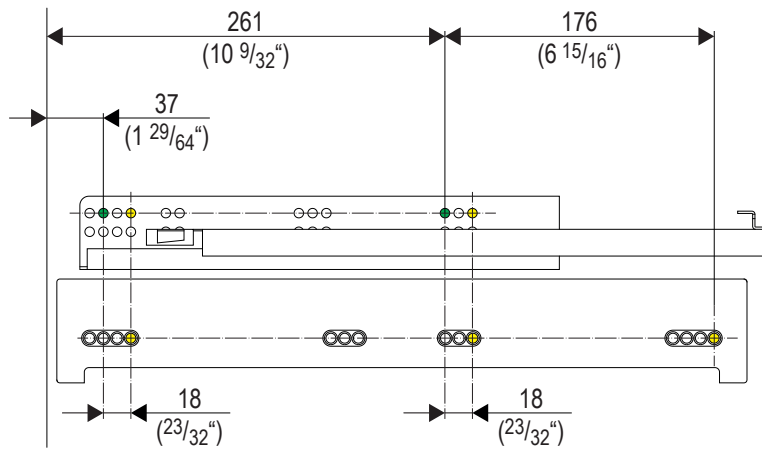
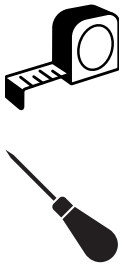

1a.1

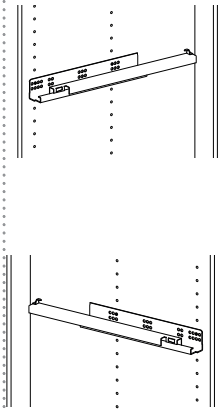
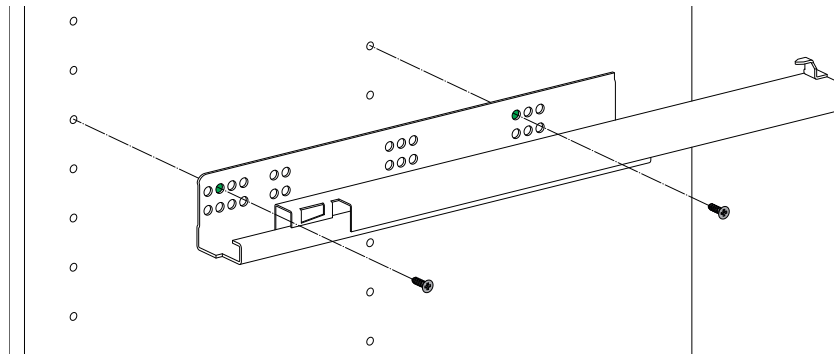
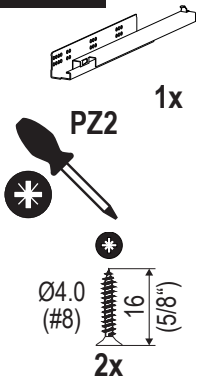

1a.2

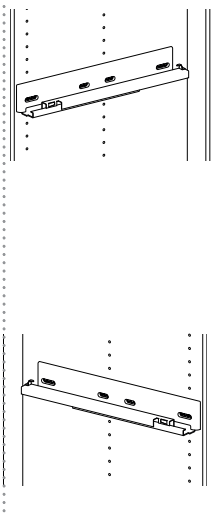
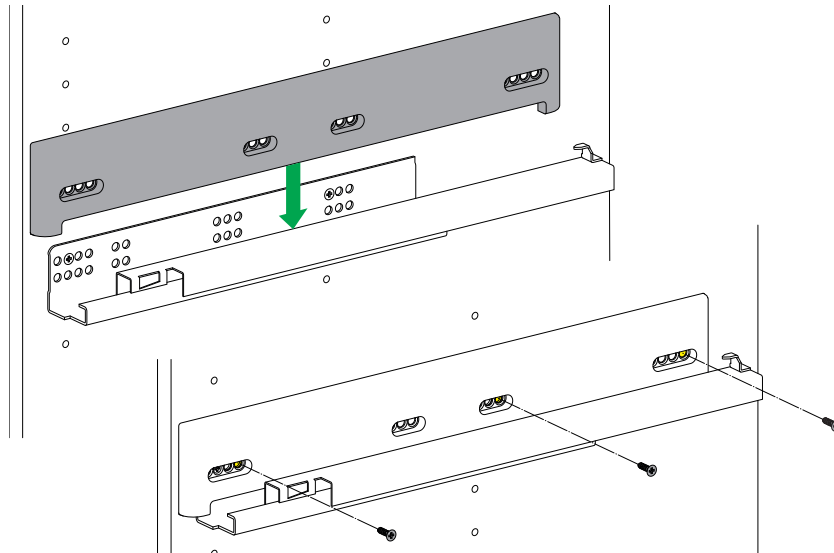

# CONERO

## Inside Pullout 168 H 475



### 1b.1

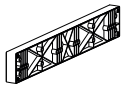

1x

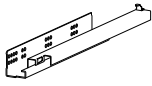

1x



PZ2

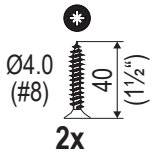

2x

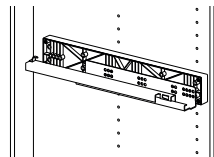
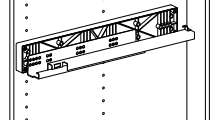
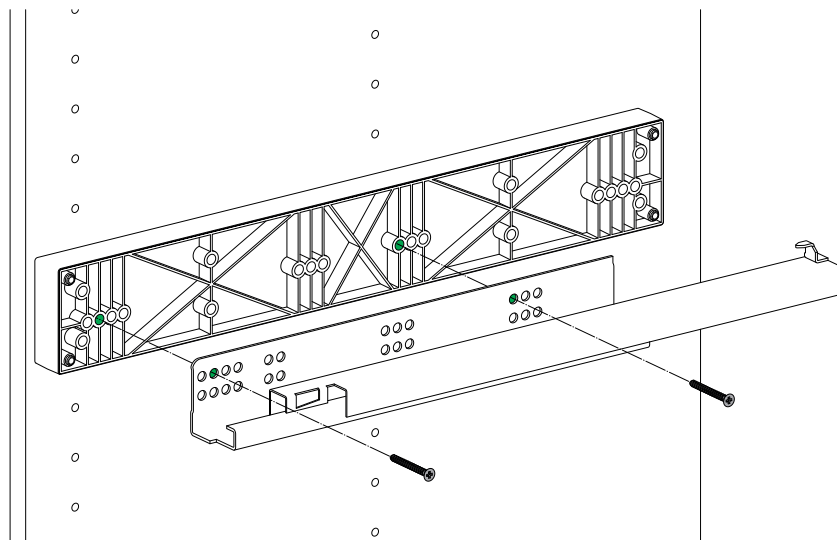

### 1b.2

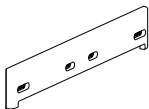

2x



PZ2

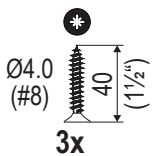

3x

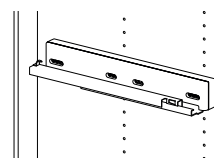
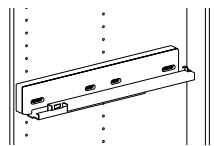
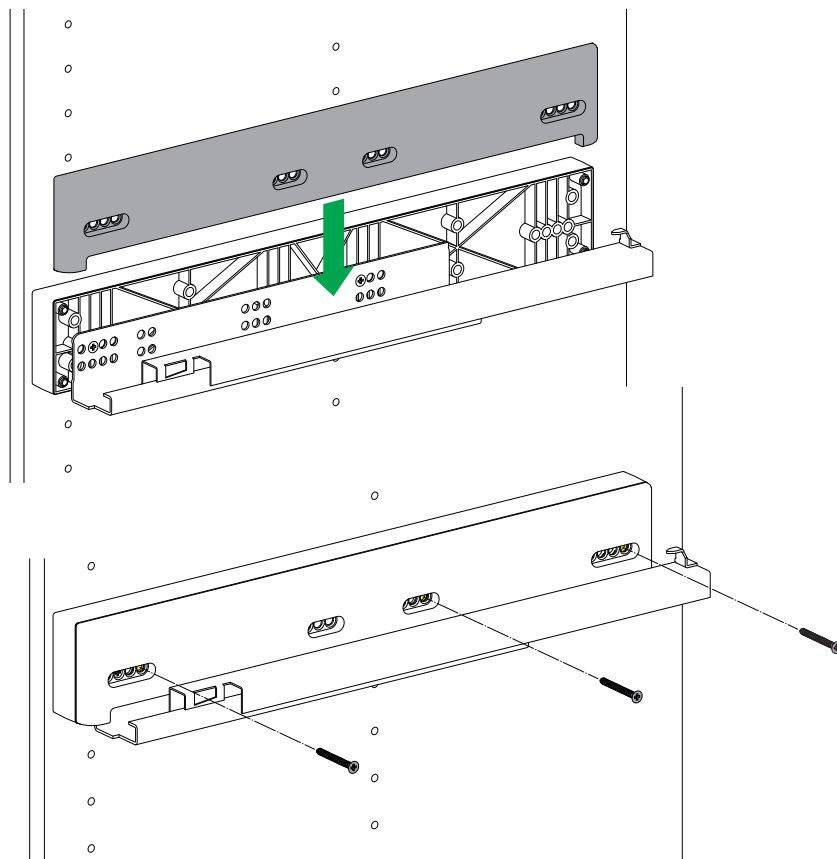

# CONERO

## Inside Pullout 168 H 475



### 1c.1

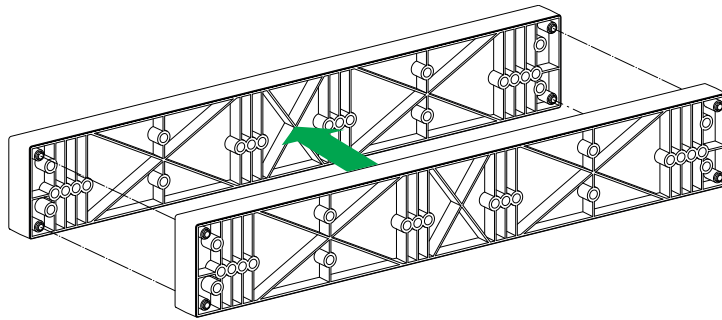
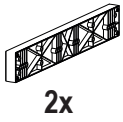

### 1c.2

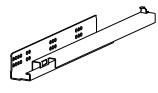
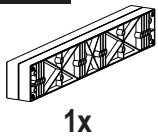

1x



PZ2

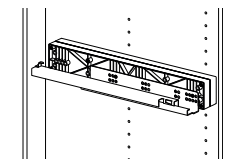
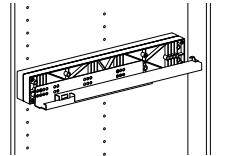
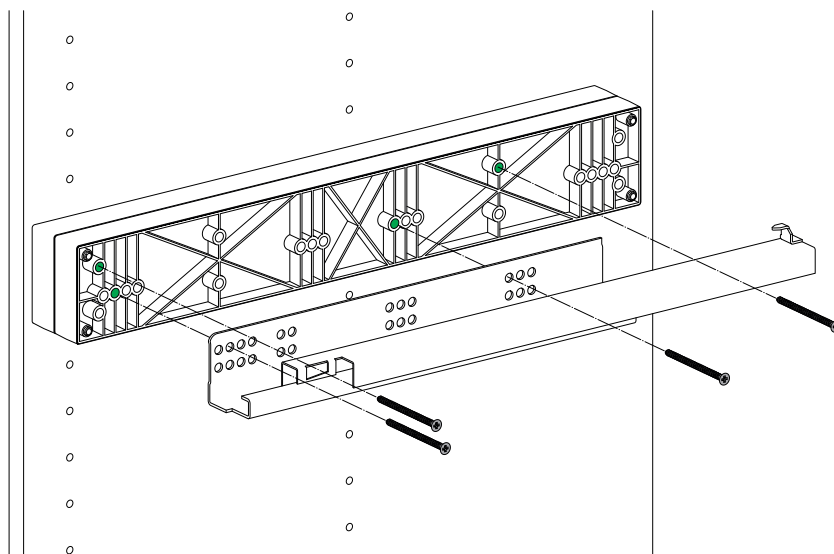
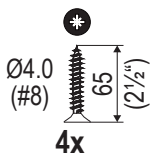

### 1c.3

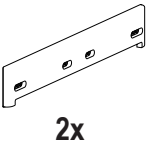

PZ2

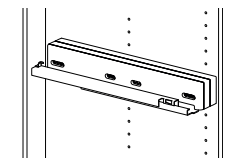
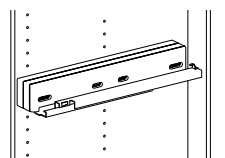
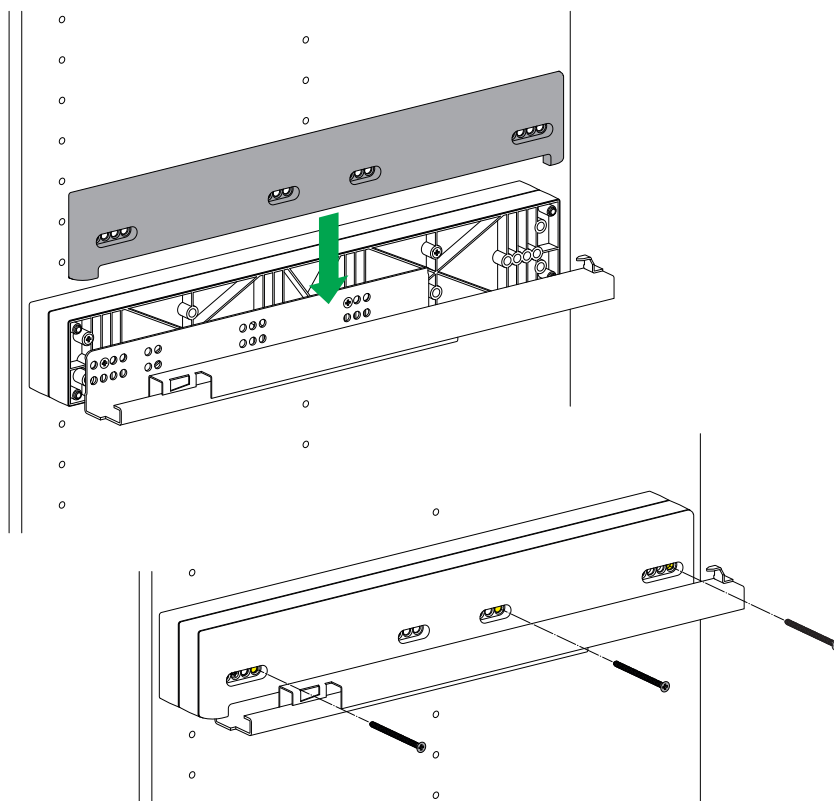
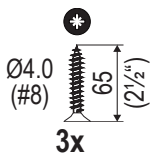

# CONERO

## Inside Pullout 168 H 475



**i**

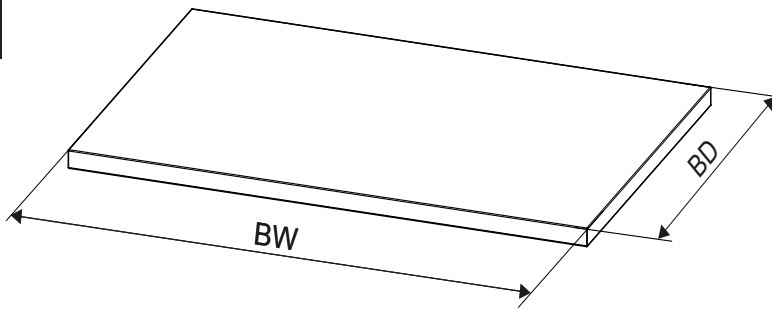

**i**

**2**

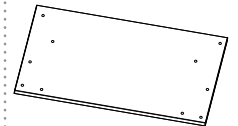
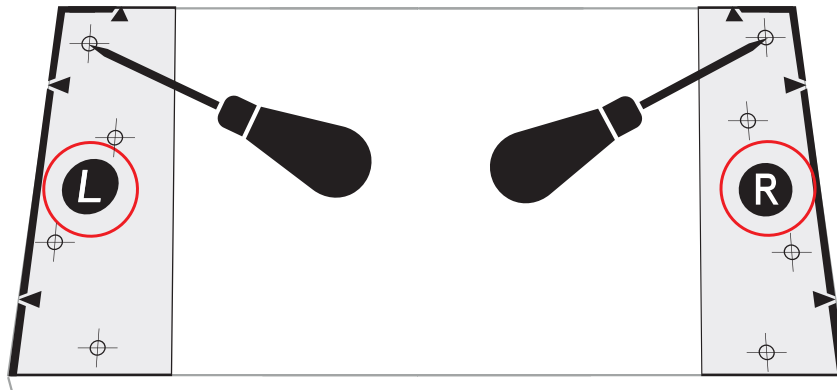
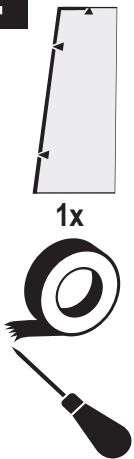

**3a**

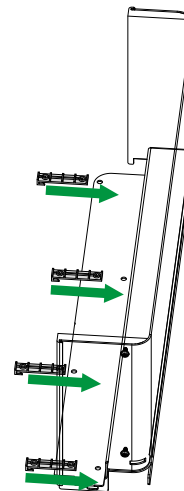
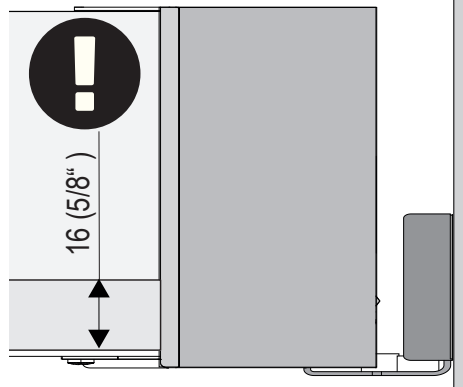
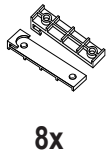

**3b**

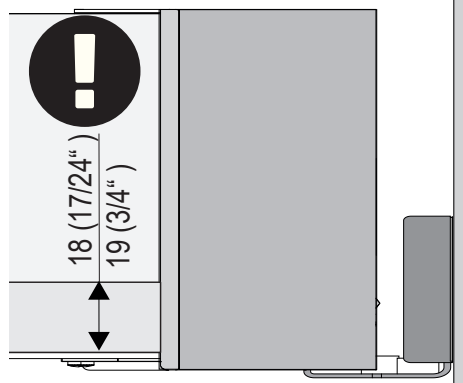
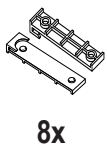

# CONERO

## Inside Pullout 168 H 475



4

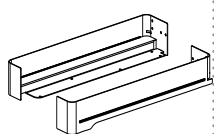

1x



1x

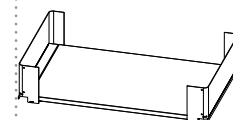
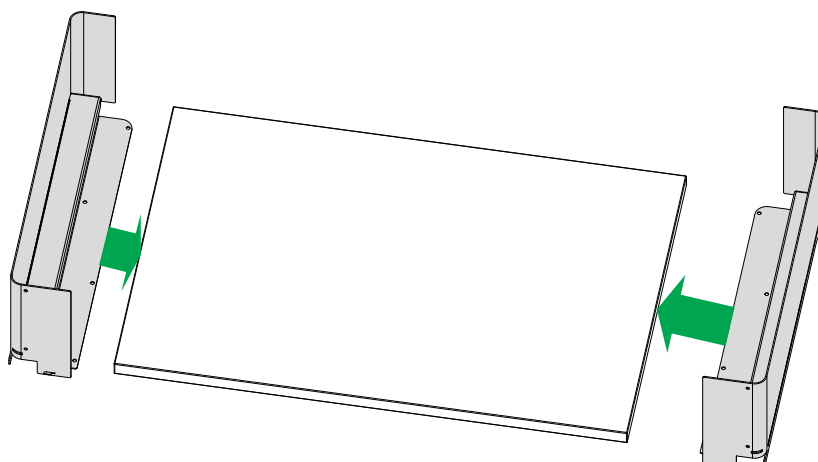

5

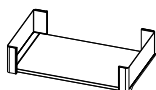

1x



1x



1x



1x

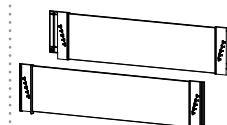

# CONERO

## Inside Pullout 168 H 475



### 6.1

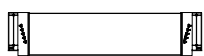

1x

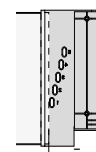
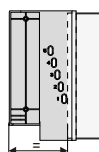
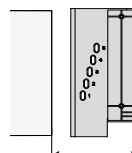
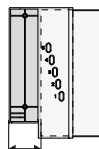
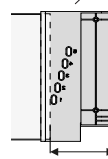
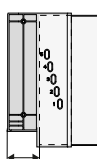
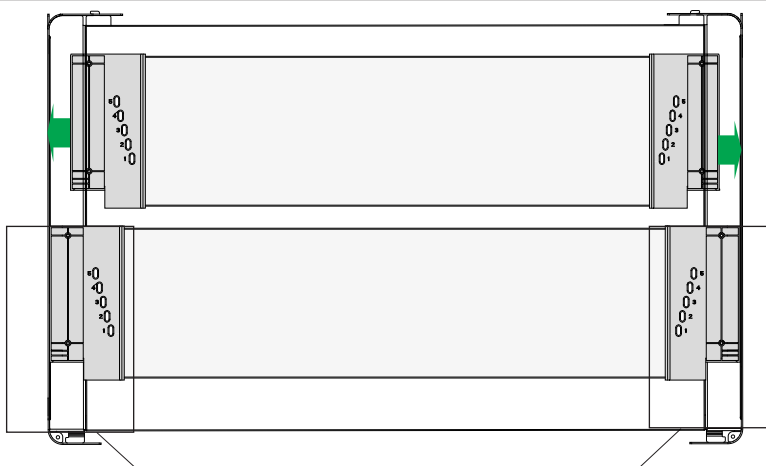

### 6.2a

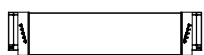

1x



2x

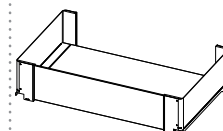
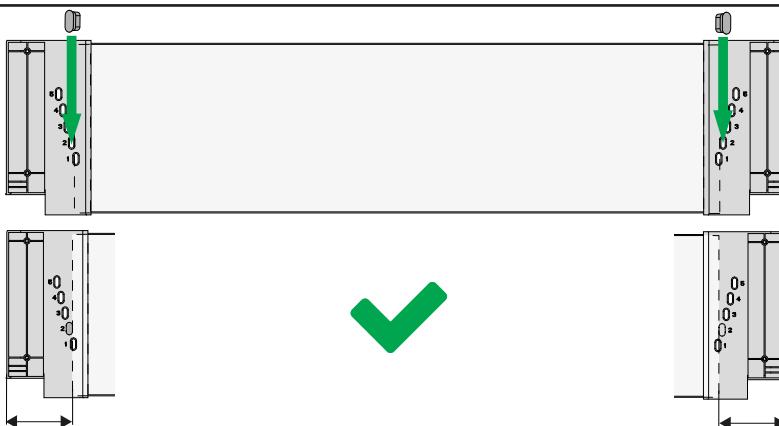

### 6.2b



2x

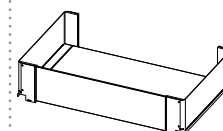



# CONERO

## Inside Pullout 168 H 475



### 7.1

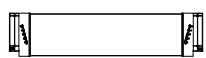

1x

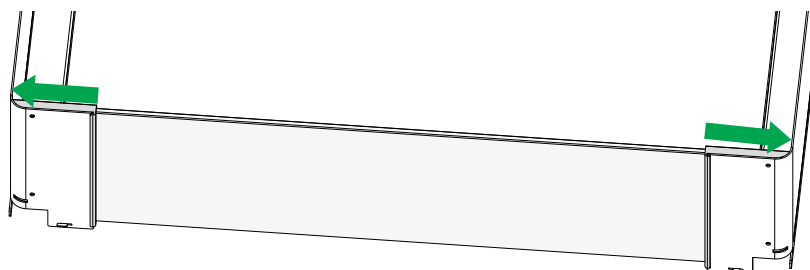

### 7.2

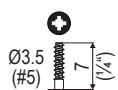

4x

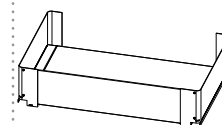
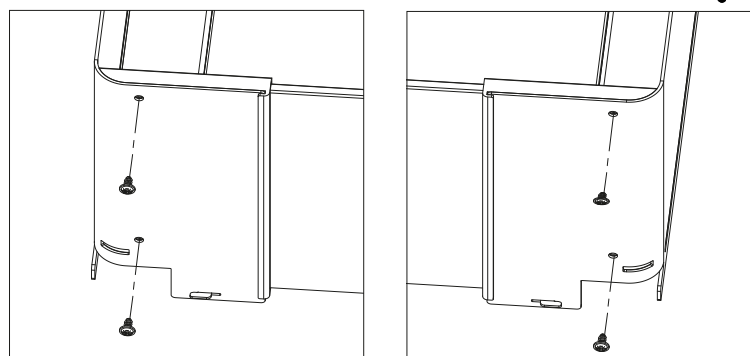
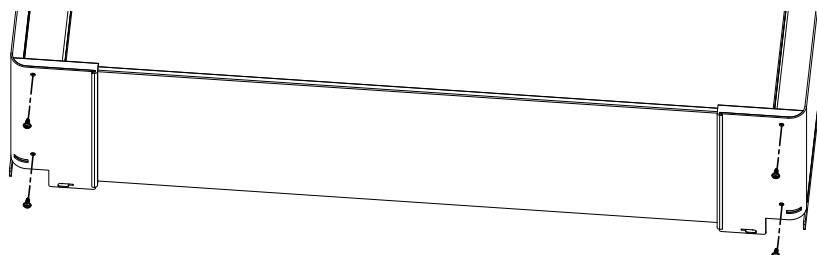

### 8.1

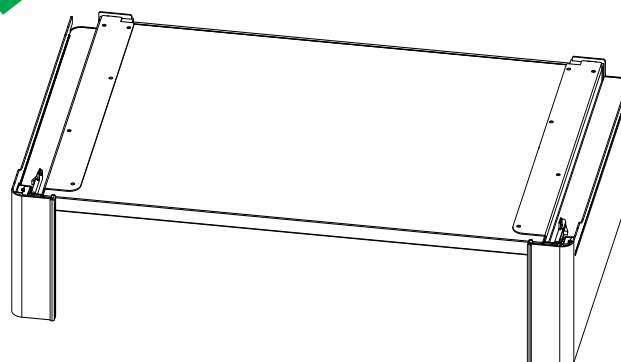
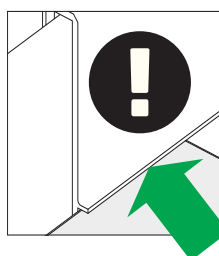
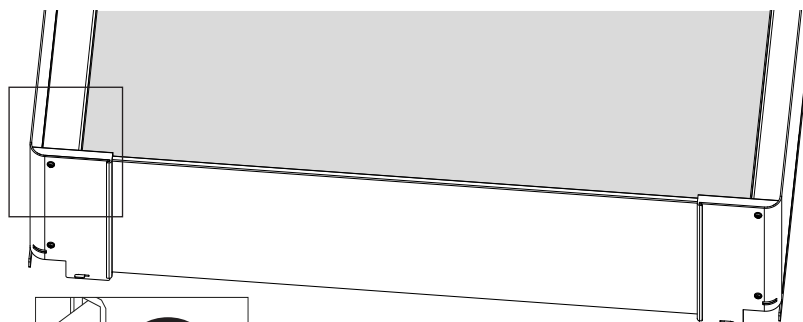

# CONERO

## Inside Pullout 168 H 475



### 8.2

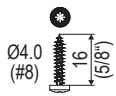

1x

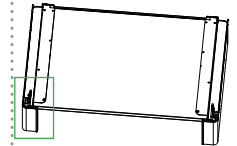
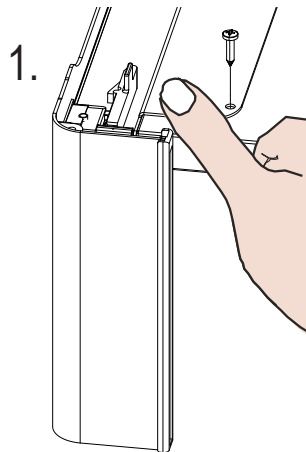

### 8.3

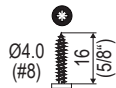

1x



2.

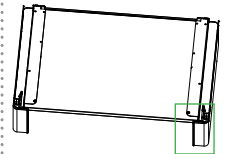
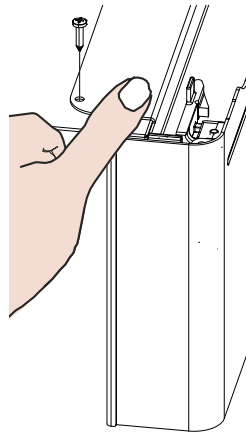

### 8.4

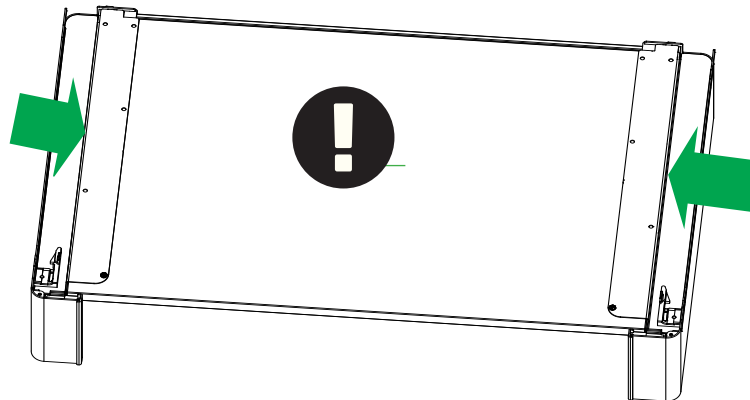

### 8.5

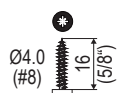

6x

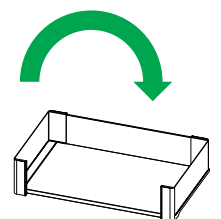
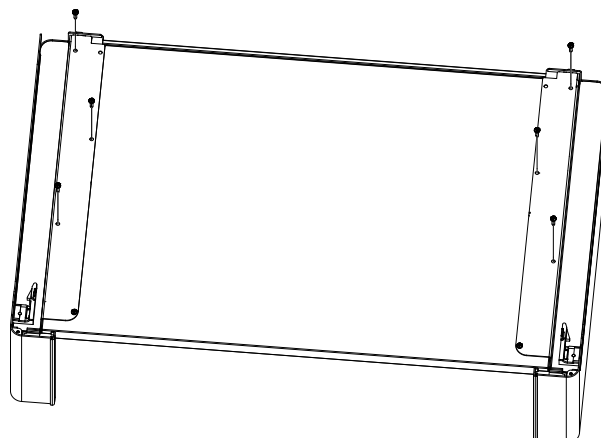

# CONERO

## Inside Pullout 168 H 475



### 9.1

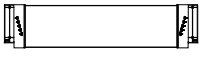

1x

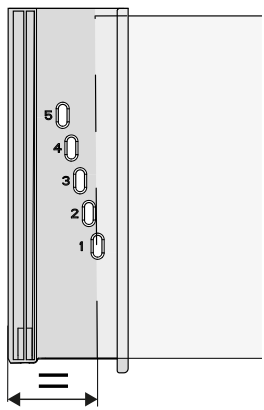
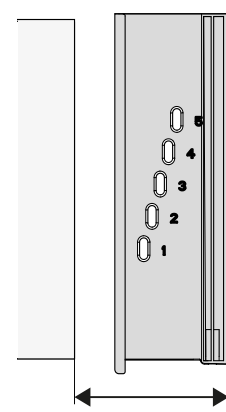
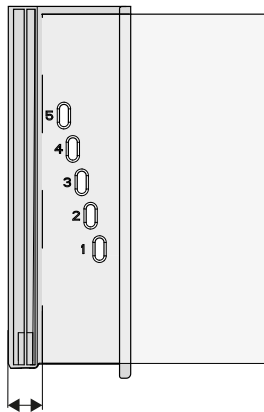
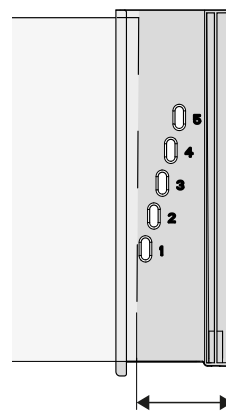
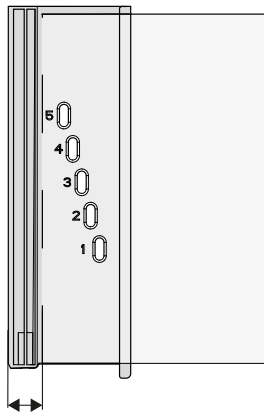
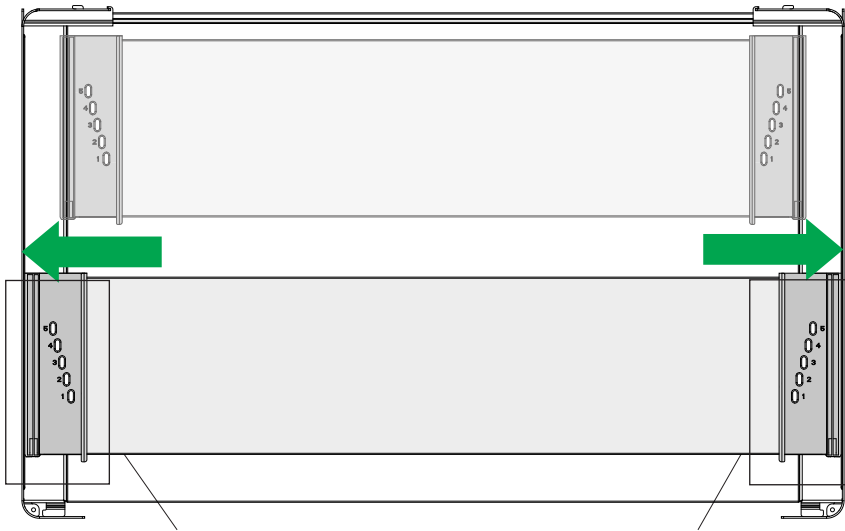

# CONERO

## Inside Pullout 168 H 475



### 9.2a



2x

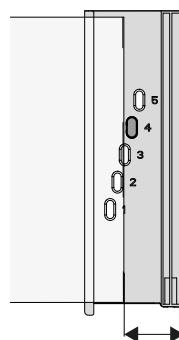
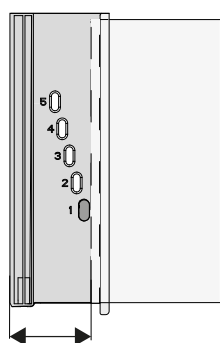
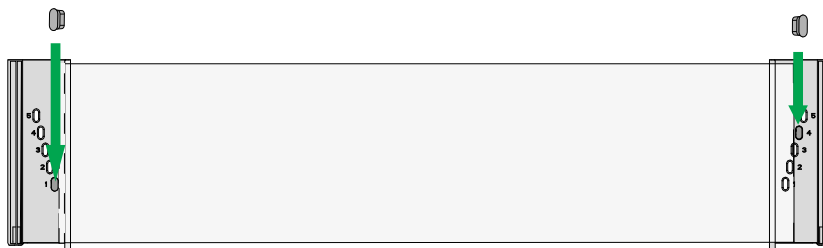

### 9.2b



2x

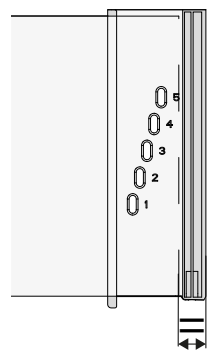
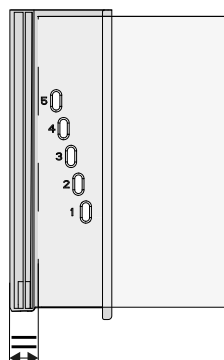
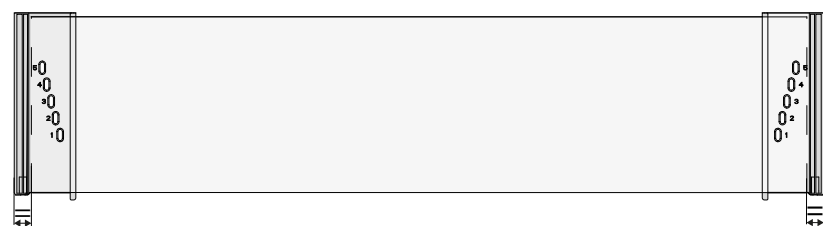

# CONERO

## Inside Pullout 168 H 475



10

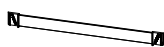

1x

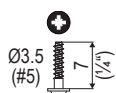

2x

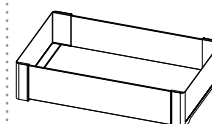
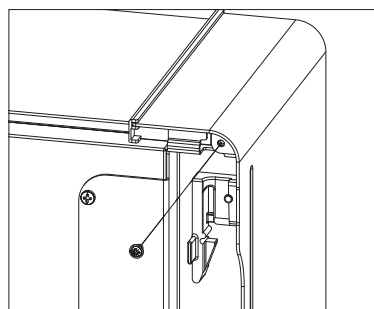
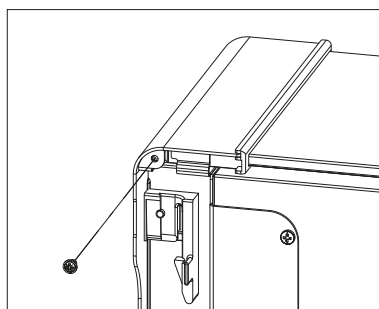
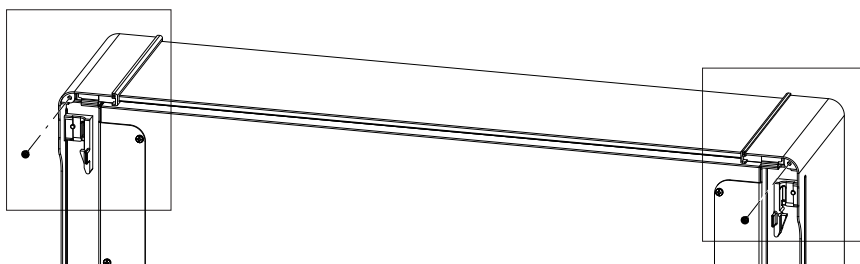
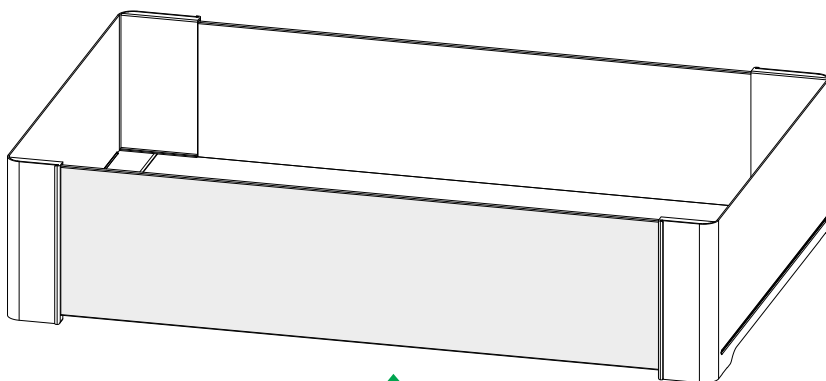

# CONERO

## Inside Pullout 168 H 475



11

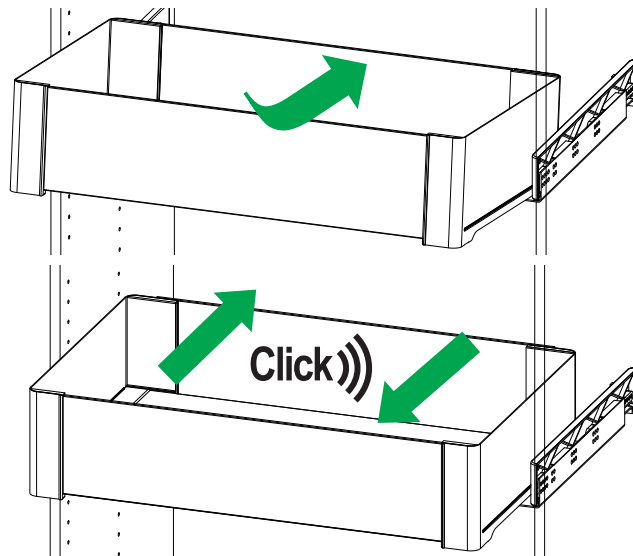

12.1

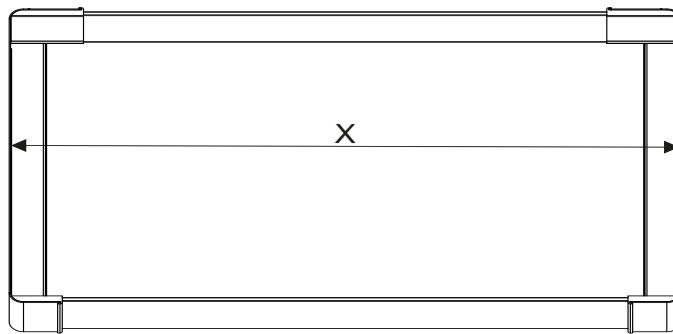
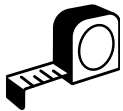

12.2



optional

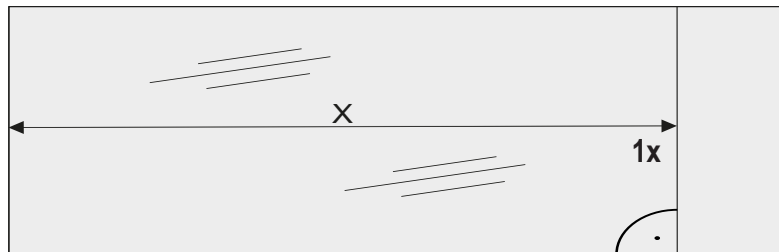
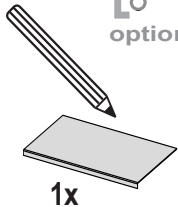

12.3

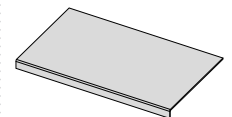

12.4



optional

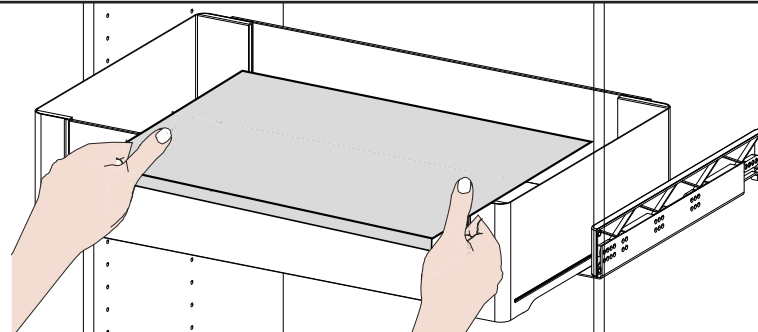
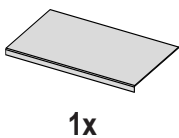

# CONERO

## Inside Pullout 168 H 475



**i**

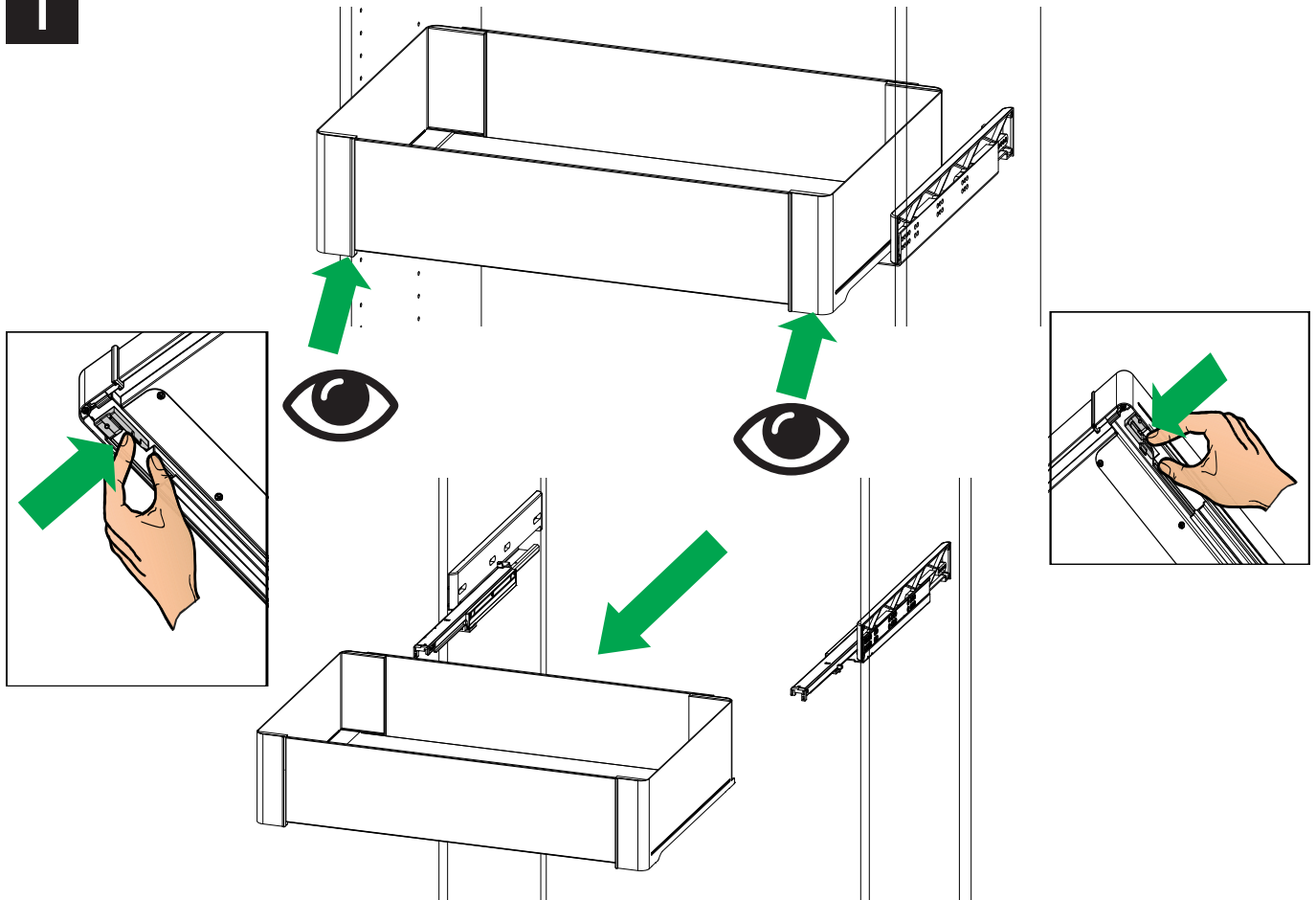

**i**

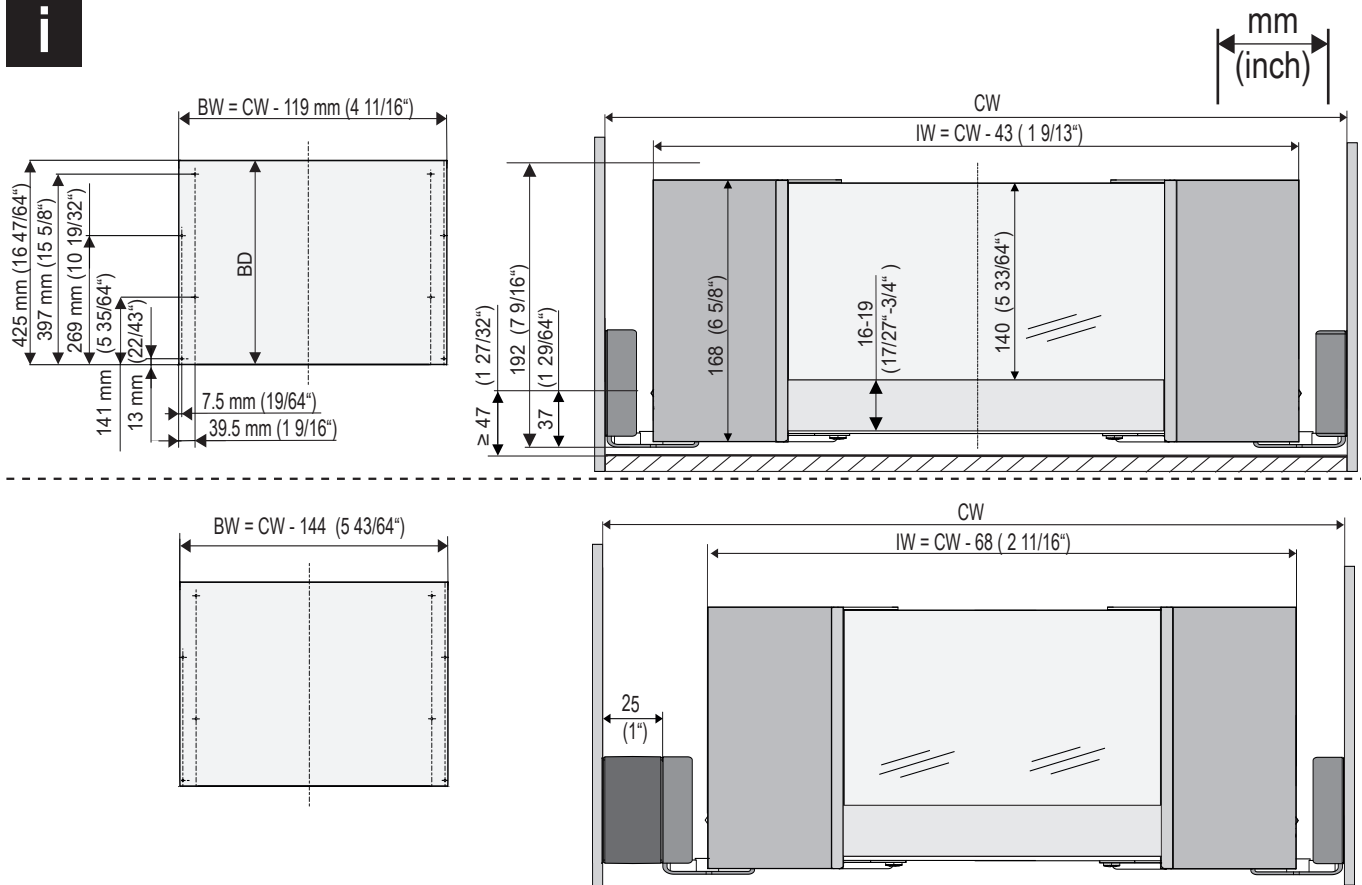

# CONERO

## Inside Pullout 168 H 475



**i**

mm  
(inch)

