

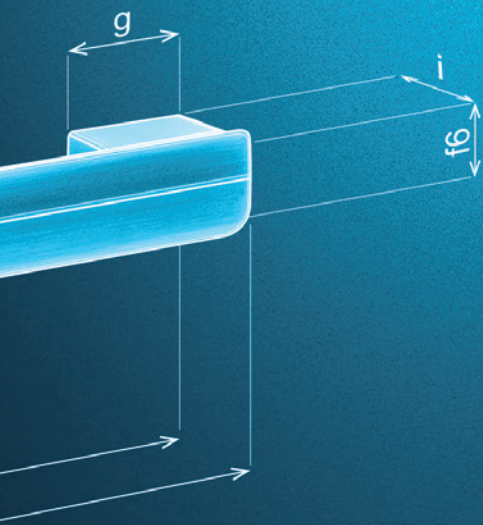

úchytky, úchytové profily, vešniaky



SAMOSTATNÝ KATALÓG

Kompletný prehľad s ukázkami úchytiak v interiéri, to je samostatný dizajnový katalóg úchytiak Tulip. Využite ho pri výbere so zákazníkom.



3D MODELY DO PROGRAMOV NA PLÁNOVANIE NÁBYTKU

Všetky úchytky máme pripravené v 3D pre plánovacie programy. Stiahnete si ich na našom portáli demos24plus.com.



UKÁŽKY NA VZORKOVNIACH

Najlepšie ako si úchytky vybrať, je naživo. Na vzorkovniach ich máme pripravené tak, aby si ich záujemca mohol priložiť k vybranému dekoru dverkoviny.



PORTÁL

Zákaznícky portál na nakupovanie, prehľad objednávok, zadávanie zákaziek, formátovanie a overenie ich stavu. Zároveň tu na jednom mieste nájdete informácie o skladových zásobách, cenách a mnoho ďalšieho.



PORADENSTVO

Neviete si poradiť s výberom kovania alebo s jeho montážou? Zavolajte na číslo +421 285 0030 alebo napíšte na adresu objednavkySK@demos-trade.com a my vám radi poradíme.



RÝCHLOSŤ DODANIA

Všetky objednávky doručíme do vašich rúk už nasledujúci deň.



obsah

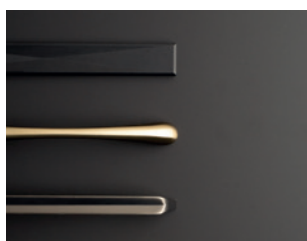

kovové úchytky a knopky

Tulip	11.15
Marella	11.77
Hettich	11.85

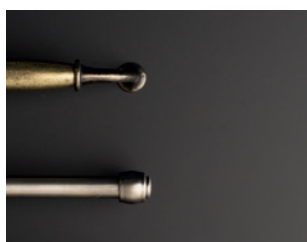

rustikálne a porcelánové

Tulip	11.38
Marella	11.80



zápustné úchytky a profily

Tulip	11.45
Hettich	11.89
Marella	11.84



drevené a kožené

Tulip	11.61
-------	-------

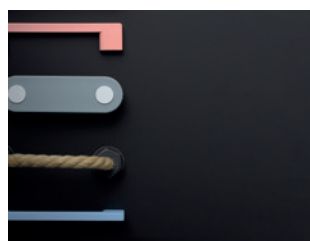
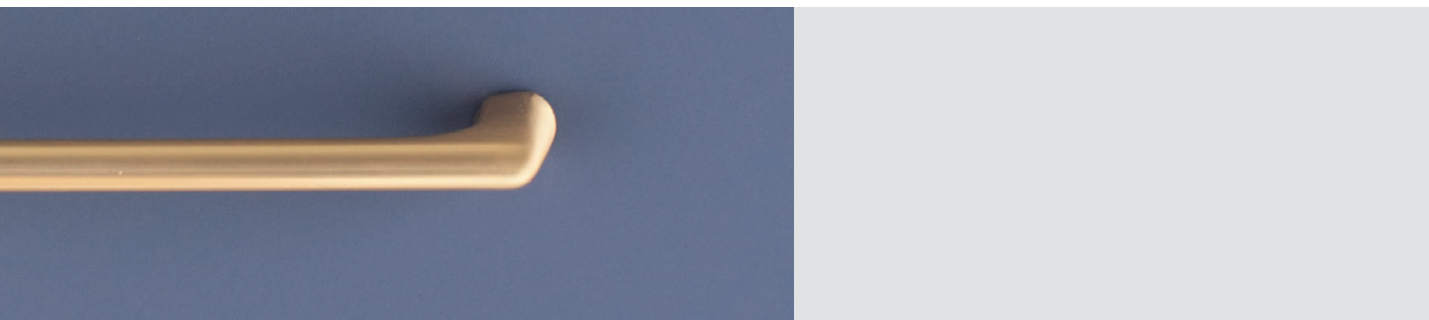

detské
a plastové

Tulip

11.66

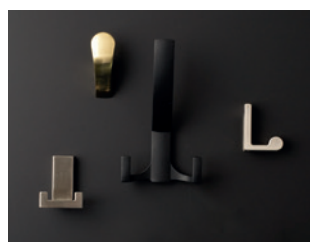

vešiaky

Tulip

11.69



úchytky, knopky,
vešiaky

Marella
Hettich

11.77
11.85

Použité skratky materiálov:

[Zn]	[Alu]	[Fe]	[Zamac]	[Stainless steel]	[PWC]	[L]
zinok	hliník	ocel'	zamac	nehrdzavejúca ocel'	polypropylén drevitá celulóza	koža

prehľad farieb

Prehľad farieb úchytiek a vešiakov



chróm



starozlatá



nehrdzavejúca oceľ

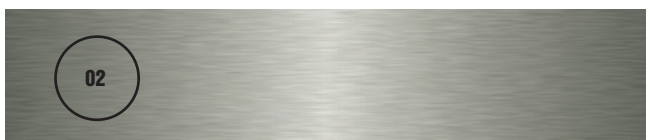

bronz

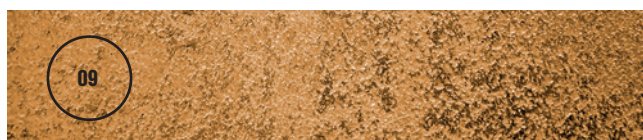

imitácia nehrdzavejúcej ocele



starobronz

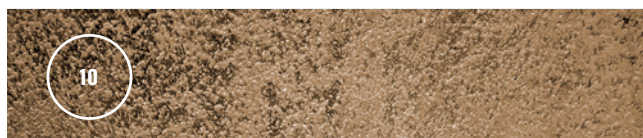

nikel

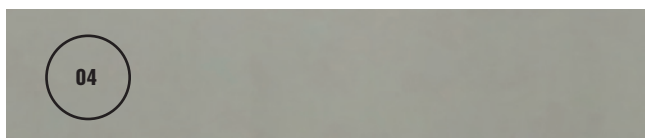

meď



nikel tmavý

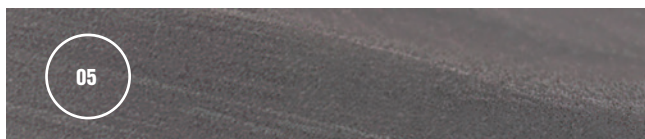

staromeď



eloxovaný hliník



strieborná



zlatá



cín



❗ Úchytky majú rôznu povrchovú úpravu: brúsenú, lesklú, matnú. Jednotlivé farby a dekory úchytiek sa môžu v závislosti od modelu mierne líšiť vo farebnosti.

starocín



koža

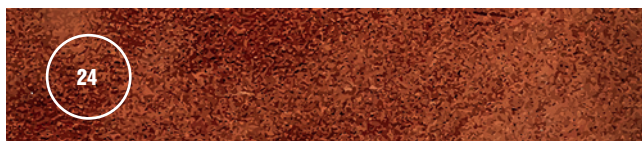

antracit



tmavá zlatá



čierna



champagne zlatá



staročierna

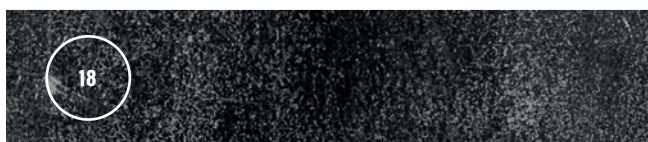

coffee



hnedá



champagne bronz

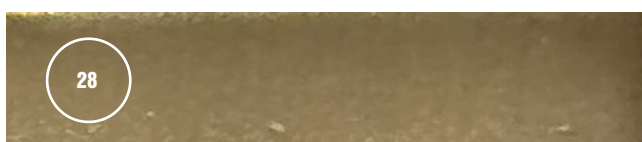

biela

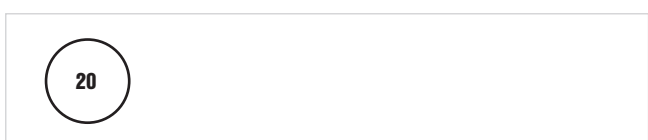

titanium

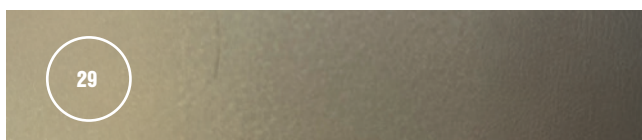

drevo



steel grey

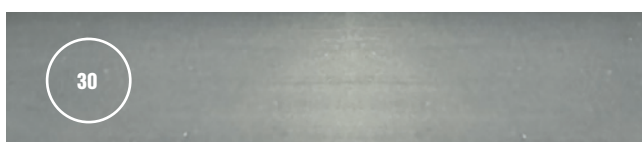

plast



beton

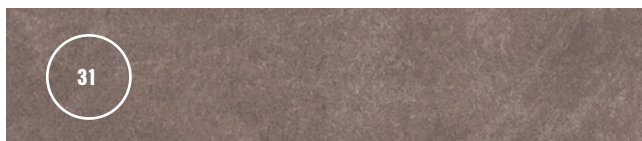

porcelán







































earth



prehľad úchytiiek a vešiakov

Prehľad úchytiiek a vešiakov



	Tonk 11.15		Iris 11.17		Boise 11.19		Nakana 11.21
	Scala 11.15		Oga 11.17		Joliet 11.19		Luca 11.21
	Scoop 11.15		Muta 11.17		Lenox 11.19		Ulica 11.21
	Peblo 11.15		Peca 11.17		Cory 11.19		Menusa 11.21
	Wake 11.16		Recife 11.18		Mount 11.19		Rocata 11.22
	Asama 11.16		Palm 11.18		Resina 11.20		Sosa 11.22
	Umberto 11.16		Recife II 11.18		Davide 11.20		Bastone 11.22
	Marca 11.16		Enuca 11.18		Marina 11.20		Lacata 11.22
	Cub 11.16		Mella 11.18		Penka 11.20		Ida 11.23



Kira 11.23



Hrazda 11.24



Porta 11.24



Wakano 11.25



Jakoto 11.25



Likano 11.25



Hytech 11.25



Zuzana 11.25



Napa 11.26



Isola 11.26



Yuma 11.26



Acri 11.26



Envel 11.26



Sulky 11.27



Kentucky 11.27



Kink 11.27



Halti 11.27



Andrea 11.27



Besina 11.27



Nomina 11.28



Ruona 11.28



Piombina 11.28



Iluna 11.28



Beta 11.29



Anita 11.29



Uroso 11.29



Unesa 11.30



Palin 11.30



Vali 11.30



Sema 11.30



Kewina 11.31



Pelena 11.31



Malada 11.31



Sakita 11.31



Geneda 11.31



Fiona 11.31



Ruota 11.32



Kutta 11.32



Ruota 11.32



Enza 11.32



Kutta 11.32



Enza 11.32





































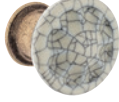





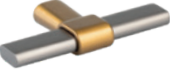

Blink 11.33



Tonk 11.33

prehľad úchytiiek a vešiakov

	Mesa	11.33		Evan	11.35		Tinto	11.37		Victoria	11.38
	Envel	11.33		Koby	11.35		Kentucky	11.37		Turia	11.39
	Kink	11.33		Marusa	11.35		Peca	11.37		Rustik	11.39
	Bella	11.33		Galka	11.35		Prisma	11.37		Country	11.39
	Conic	11.34		Tomic	11.36		Frame	11.37		Turia	11.39
	Mella	11.34		Boise T	11.36	Rustikálne				Rustik	11.39
	Andrea	11.34		Peblo	11.36		Menfi	11.38		Country	11.39
	Iroko	11.34		Boise O	11.36		Tomo	11.38		Gipa	11.40
	Ota	11.34		Joliet	11.36		Victoria	11.38		Sara	11.40
	Ruza	11.34		Recife II	11.36		Menfi	11.38		Margarita	11.40
	Jota	11.35		Hrazda	11.37		Tomo	11.38		Gipa	11.40



Sara 11.40



Margarita 11.41



Vintage 11.41



Serena 11.41



Vintage 11.41



Serena 11.41



Corsica 11.42



Cona 11.42



Loka 11.42



Bold 11.42



Kaniva 11.43



Panel F 11.43



Ring F 11.43



Avoca 11.44



Shellby 11.44



Misura 11.44



Anetta 11.44



Nave 11.44



Carpi 11.44



Gliss 11.45

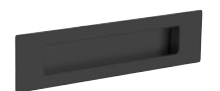

Madrid 11.45



Rapid 11.45



Dunk 11.45



Rulida 11.45



Orinoco 11.45



Pesara 11.46



Malena 11.46



Concava 11.46



Lori II 11.47



Nary 11.47



Bowie 11.48



Lucata 11.48



Sophia 11.49



Ramara 11.49



Tende 11.50



Zoid 11.50



Juvio 11.51



Juvio L 11.51



Paolo 11.51

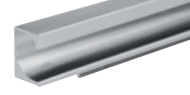

Paolo L 11.51

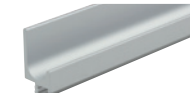

Fano 11.52



Lungo 11.52

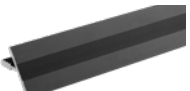

Ria 11.52

prehľad úchytiiek a vešiakov

Drevené a kožené



Berga 11.61



Metra 11.61



Boise 11.61



Lynn 11.61



Beam 11.61



Rail 11.61



Mewo 11.62



Xin 11.62



Lines 11.62



Mewo 11.62



Vasca 11.62



Tine 11.63



Wave 11.63



Ames 11.63



Chico 11.63



Moku 11.63



Ames 11.63



Square 11.64



Taper 11.64



Jacek 11.64



Hole 11.64



Jura 11.64



Adam 11.65



Bala 11.65



Sola 11.65

Detské



Cute 11.66



P431 11.66



Spaccata 11.66



Cute 11.66



P439 11.66



Spaccata 11.66



Cana 11.67



Palla 11.67



Funga 11.67



Bottone 11.67



Large 11.68



Into 11.68



Filip 11.69

Vešiaky



Balo 11.69



Troy 11.69



Element 11.69

ÚCHYTKY, ÚCHYTOVÉ PROFILY, VEŠIAKY
prehľad úchytek a vešiakov

	Rudi	11.69		Kara M	11.71		Cid XL	11.73		Orio	11.75
	Boise	11.69		Marell	11.71		Marcel XL	11.73		Murero XL	11.75
	Doris	11.70		Gant	11.72		Lugo XL	11.73		Rubico XL	11.75
	Rini	11.70		Dax	11.72		Muso	11.74		Orio XL	11.75
	Peri	11.70		Ener	11.72		Livorno	11.74		Balo XL	11.76
	Dyan	11.70		Gant XL	11.72		Darec	11.74		Xin	11.76
	Rini XL	11.70		Iwo	11.72		Lerico	11.74		Twist	11.76
	Peri XL	11.70		Ener XL	11.72		Rokos	11.74		Extendo XL	11.76
	Pera	11.71		Cid	11.73		Darec XL	11.74			
	Kara S	11.71		Marcel	11.73		Murero	11.75			
	Kara L	11.71		Lugo	11.73		Rubico	11.75			

prehľad úchytiak a vešiakov

Marella



Vitruvio 11.77



Lama 11.77



Tonda 11.77



Torus 11.78



Linæ 11.79



Torus 11.78



Riva 11.78



Riva 11.78



Brera 11.79



Defense 11.79



Art Decó 11.80



Viaggio 11.80



Viaggio 11.80



Sirius 11.81



Columnæ 11.81



Macis 11.81



Columnæ 11.81



Macis 11.81



Augusto 11.82



Smarty 11.82



Aramis S 11.82



Tiberio 11.82



Jonathan 11.82



Aramis M 11.82

Hettich



Anzio 11.85



Bermeo 11.85



Intra 11.85



Salacia 11.86



Chalcis 11.86



Baldone 11.86



Naila 11.86



Catana 11.87



Salona 11.87

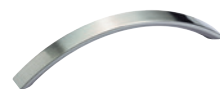

Balmo 11.87



Vantania 11.87



Egara 11.87



Genoa 11.87



Fermo 11.88



Coria 11.88



Monacum 11.88



Messana 11.88



Haida 11.88

	Almus	11.88
	Gela	11.89
	Gela a Galati	11.89
	Empoli	11.89
	Galati	11.89
	Aboa	11.89
	Narni	11.89
	Nidum	11.90
	Touch - in	11.90
	Touch - in	11.90

Tonk [Zamac]

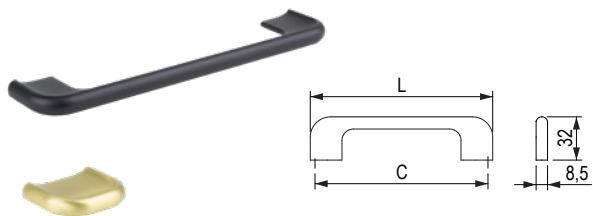

☞ str. 11.33

nikel brúsený	čierna matná	zlatá brúsená	rozstup vŕtania C (mm)	dĺžka L (mm)
489337	489336	489338	160	135
489340	489339	489341	320	167

Scoop [Zamac]

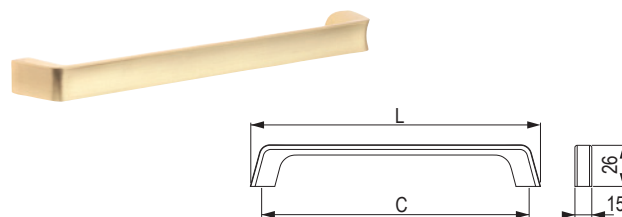

zlatá matná	meď matná	rozstup vŕtania C (mm)	dĺžka L (mm)
351843	351845	160	180
351844	351846	320	340

Scala [Alu]

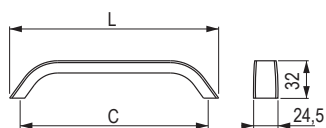

hnedá matná	eloxovaný hliník	imitácia nehrdzavejúcej ocele	čierna brúsená	rozstup vŕtania C (mm)	dĺžka L (mm)
×	227248	227239	544812	128	147
261978	227249	227240	378651	160	179
261979	227250	227242	378652	192	211
261980	227251	227243	378653	224	243
261981	227252	227244	378654	320	339
×	×	227245	378655	448	467
×	×	227246	378656	544	563
×	×	227247	378657	640	659

Peblo [PWC]

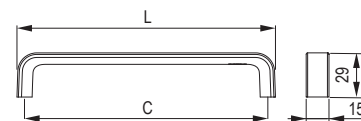

earth	beton	rozstup vŕtania C (mm)	dĺžka L (mm)
543774	543773	160	170

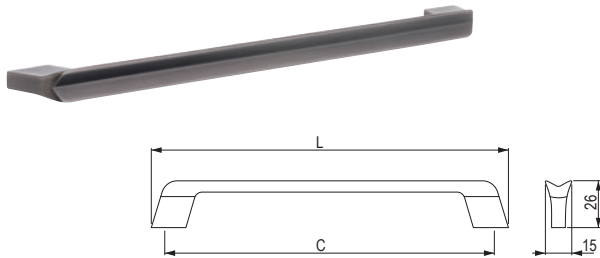

Wake [Zamac]



	rozstup vrtania C (mm)	dĺžka L (mm)
nikel tmavý brúsený		
401562	160	180
401563	320	340

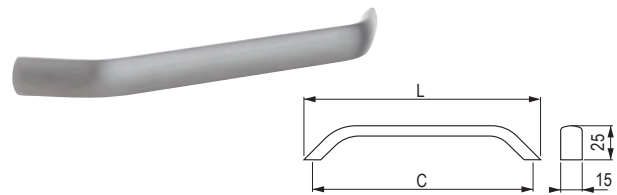

Marca [Alu]

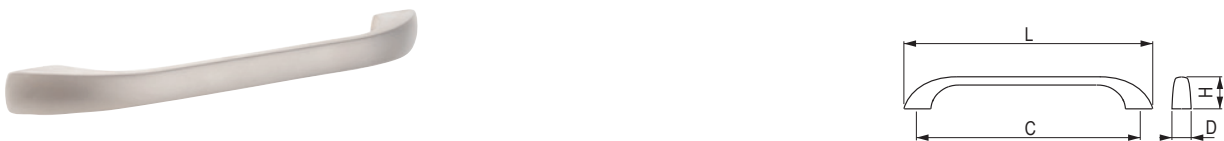

		rozstup vrtania C (mm)	dĺžka L (mm)
imitácia nehrdzavejúcej ocele	čierna brúsená		
225008	544813	160	197
225009	544814	192	229
225010	544815	224	261
225011	544816	320	357
225012	544817	448	485

Asama [Zn]



			rozstup vrtania C (mm)	dĺžka L (mm)	šírka D (mm)	výška H (mm)
chróm matný	nikel brúsený	nikel matný				
157231	157234	157228	160	204	17	26
157232	157235	157229	192	245	18	29

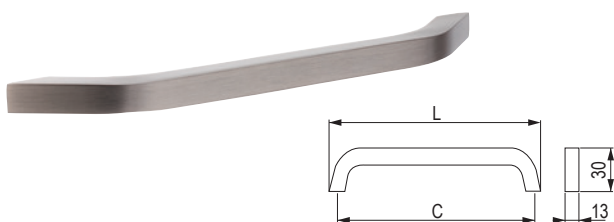

Umberto [Zamac]



	rozstup vrtania C (mm)	dĺžka L (mm)
chróm matný		
192369	192	214
192370	256	278
192371	320	345
192372	448	470

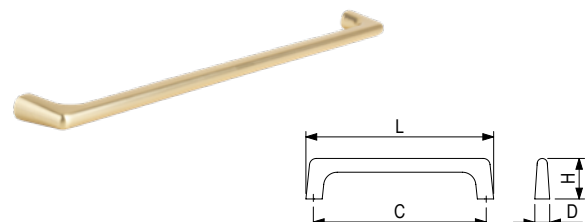

Cub [Zn]



			rozstup vrtania C (mm)	dĺžka L (mm)	šírka D (mm)	výška H (mm)
čierna matná	nikel brúsený	champagne zlatá				
494759	494758	494760	128	139	11	30
494762	494761	494763	192	203	11,8	31,3
494765	494764	494766	320	335	13,7	31,8

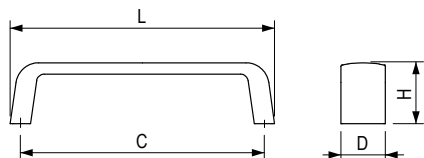

Iris [Alu]



 nikel brúsený	 čierna matná	rozstup vŕtania C (mm)	dĺžka L (mm)	šírka D (mm)	výška H (mm)
308974	544818	96	104	14	18,7
308975	544819	128	136	17	22,3
308976	544820	160	168	17,6	22,6
308977	544821	192	200	18,1	23,6

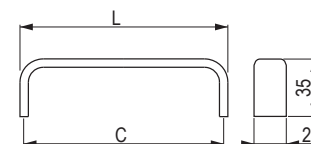

Muta [Alu]

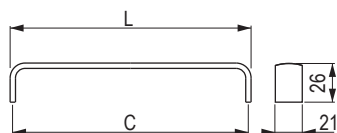

 eloxovaný hliník	 imitácia nehrdzavejúcej ocele	rozstup vŕtania C (mm)	dĺžka L (mm)
36821	36829	128	136
36822	36830	160	168
36823	36831	192	200
36824	36832	224	232
36825	36833	320	328
36826	36834	448	456

Oga [Zn]





 chróm matný	 nikel brúsený	rozstup vŕtania C (mm)	dĺžka L (mm)
157203	157199	96	102
157204	157200	128	134
157205	157201	160	166
157206	157202	192	198

Peca [Zn]



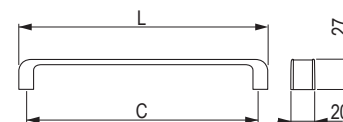

 str. 11.37

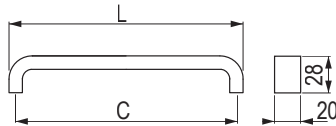

 chróm lesklý/ imitácia nehrdzavejúcej ocele	 chróm lesklý/ biela matná	rozstup vŕtania C (mm)	dĺžka L (mm)
225070	227260	128	142
225071	227261	192	206
225072	225066	256	270

Recife [Zamac]



	rozstup vrtania C (mm)	dĺžka L (mm)
imitácia nehrdzavejúcej ocele		
157638	128	137
157639	192	201
157640	224	233
157641	256	265
157642	320	329
157643	448	457

Palm [Zamac]

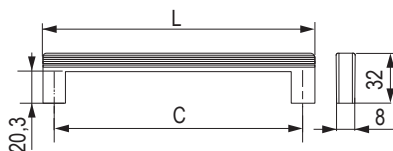





			rozstup vrtania C (mm)	dĺžka L (mm)
tmavá zlatá brúsená	steel grey	čierna matná		
547166	547164	547165	160	171

Recife II [Zamac]

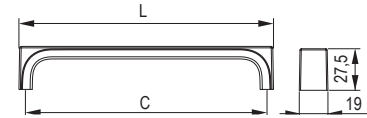



str.11.36

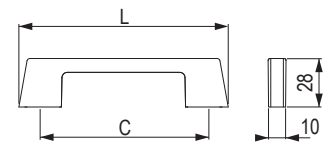

			rozstup vrtania C (mm)	dĺžka L (mm)
hnedá matná	nikel brúsený	čierna matná		
543780	543779	543778	160	169
543783	543782	543781	320	329

Enuca [Zn]



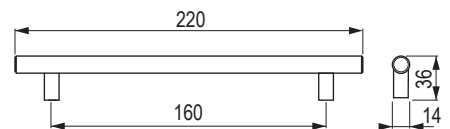

	rozstup vrtania C (mm)	dĺžka L (mm)
antracit/chróm lesklý		
284096	128	143
284097	160	190
284098	224	254
284099	320	352

Mella [Alu]



str. 11.34

	
zlatá matná	čierna matná
396165	396164

Boise [Zamac]





☑ str. 11.61



☑ str. 11.36



☑ str. 11.36

		rozstup vrtania C (mm)	dĺžka L (mm)
tmavá zlatá brúsená	čierna matná		
544832	544831	160	210
546229	546228	320	370

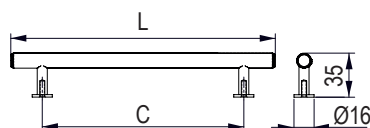



Joliet [Alu/zamac]



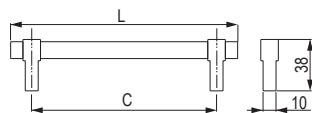

☑ str. 11.36



		rozstup vrtania C (mm)	dĺžka L (mm)
champagne bronz	steel grey/ čierna matná		
547167	547170	160	190
547168	547171	256	286
547169	547172	416	446

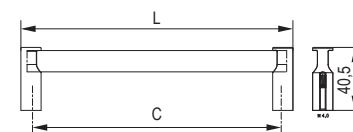

Cory [Alu]



		rozstup vrtania C (mm)	dĺžka L (mm)
dub lakovaný/ čierna brúsená	čierna brúsená		
543754	543759	160	175
543756	543757	320	335
543759	543755	1024	1039

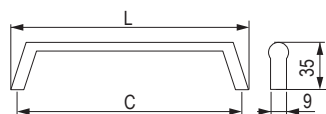

Lenox [Zamac]

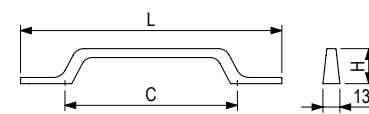

		rozstup vrtania C (mm)	dĺžka L (mm)
tmavá zlatá brúsená	čierna matná		
547158	547161	160	175
547159	547162	224	239
547160	547163	320	335

Mount [Zn]



			rozstup vrtania C (mm)	dĺžka L (mm)	výška H (mm)
nikel brúsený	čierna matná	biela matná			
494749	494750	494751	128	194	26
494752	494753	494754	192	258	27,2
494746	494747	494748	224	290	27,2

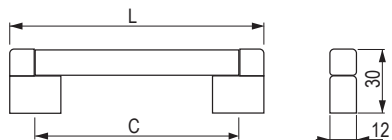
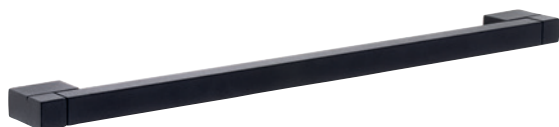

Resina [Zamac]



		rozstup vrtania C (mm)	dĺžka L (mm)
čierna matná			
500450		128	152
500451		160	184
500452		192	216
500453		224	248
500454		256	280
500455		320	344
500456		384	408
500457		448	472
500458		480	504
500459		672	696
500460		736	760
500461		832	856
399520		960	984
500462		1056	1080
399522		1184	1208

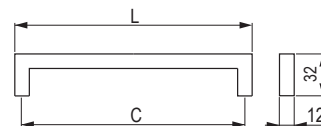

Marina [Stainless steel]

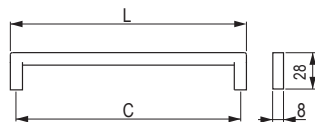

			
nehrdzavejúca oceľ brúsená	čierna matná	rozstup vrtania C (mm)	dĺžka L (mm)
203829	494687	128	140
203822	494680	160	172
203823	494681	192	204
203824	494682	224	236
203825	494683	320	332
203826	494684	480	492
203827	494685	640	652
203828	494686	736	748

Davide [Zamac]



			
nikel brúsený	chróm matný	rozstup vrtania C (mm)	dĺžka L (mm)
343940	343951	96	104
343941	343952	128	136
343942	343953	160	168
343943	343954	192	200
343944	343955	224	232
343945	343957	320	328

Penka [Zamac]

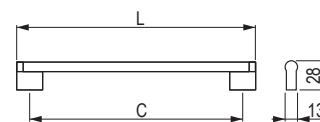

			
nikel brúsený	rozstup vrtania C (mm)	dĺžka L (mm)	
157250	128	136	
157251	160	168	
157252	192	200	
157253	224	232	
157255	320	328	
157256	448	456	

Nakana [Alu]

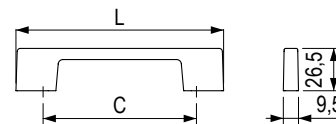

						rozstup vŕtania C (mm)	dĺžka L (mm)
biela lesklá	čierna lesklá	čierna matná	chróm matný	nikel brúsený	chróm lesklý	96	129
502023	502029	502035	502041	502047	502053	128	161
502024	502030	502036	502042	502048	502054	160	193
502025	502031	502037	502043	502049	502055	192	225
502026	502032	502038	502044	502050	502056	256	289
502027	502033	502039	502045	502051	502057	320	353
502028	502034	502040	502046	502052	502058		

Luca [Zamac]

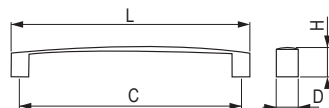

			rozstup vŕtania C (mm)	dĺžka L (mm)	šírka D (mm)	výška H (mm)
chróm matný	imitácia nehrdzavejúcej ocele	starozlatá	128	141	21	22
224941	224945	359879	160	172	21,5	23
224942	224946	359881				

Menusa [Alu]

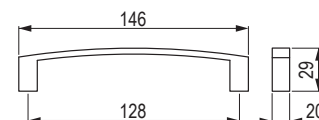

eloxovaný hliník

35971

Ulica [Zamac]

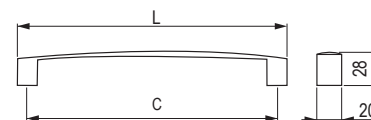

				rozstup vŕtania C (mm)	dĺžka L (mm)
nikel brúsený	chróm lesklý	imitácia nehrdzavejúcej ocele	chróm matný	128	146
355912	303317	289690	289696	160	178
355913	303318	289691	289697	192	210
355914	303319	289692	289698	256	274
355915	303320	289693	289699	320	338
355916	303321	289694	289700		

Rocata [Alu]

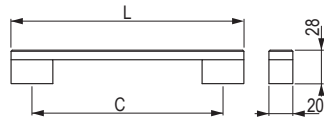

	rozstup vŕtania C (mm)	dĺžka L (mm)
čierna matná		
284104	160	203
284105	224	267
284106	320	363

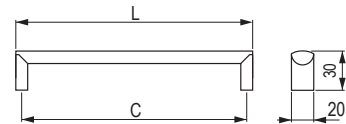

Lacata [Alu]

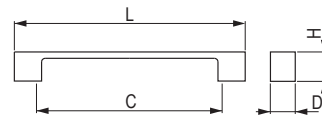

	rozstup vŕtania C (mm)	dĺžka L (mm)
imitácia nehrdzavejúcej ocele		
227223	128	138
227224	160	170
227225	224	234
227226	320	330
227227	448	458

Sosa [Zn]



			rozstup vŕtania C (mm)	dĺžka L (mm)	šírka D (mm)	výška H (mm)
chróm matný	nikel brúsený	čierna matná				
37031	37032	465322	160	190	20	24
37033	37034	465323	192	225	25	26



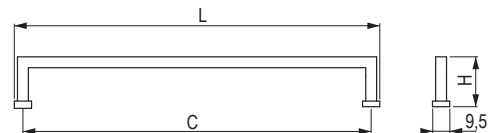

Bastone [Zamac]

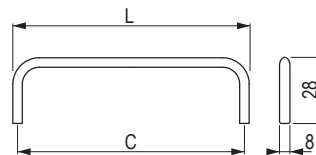

		rozstup vŕtania C (mm)	dĺžka L (mm)	výška H (mm)
chróm lesklý	čierna matná			
402388	402389	128	138	34
402391	402392	160	170	34
402453	402393	192	201,5	34
402394	402395	320	330	28



Ida ^[Fe]

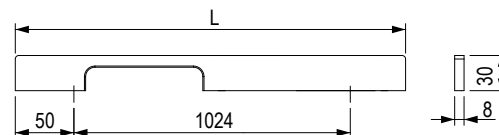
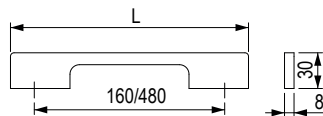
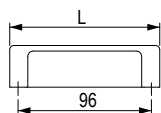

					rozstup vŕtania C (mm)	dĺžka L (mm)
35341	157542	157543	494659	494625	96	112
157544	157545	157546	494660	494626	128	146
231423	231424	231422	494661	494627	160	170

Kira ^[Alu]







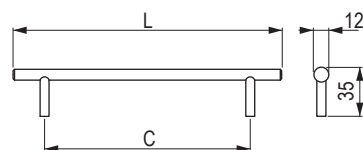

		rozstup vŕtania C (mm)	dĺžka L (mm)
494416	494415	96	108
494418	494417	160	200
494420	494419	480	500
494422	494421	1024	1200

Hrazda [Fe/Alu]









str. 11.37

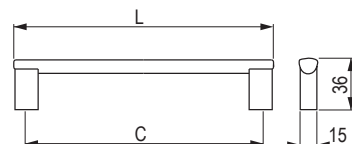

						rozstup vŕtania C (mm)	dĺžka L (mm)
35941	35942	35943	35947	10640	494607	96	136
35921	35922	35923	35927	10641	494608	128	168
35661	35662	35663	35667	10642	494609	160	200
36731	36732	36733	36737	10643	494610	192	232
35931	35932	35933	35937	10644	494611	224	264
36741	36742	36743	36747	10645	494612	288	328
35651	35652	35653	35657	10646	494613	320	360
35951	35952	35953	35957	10648	494614	448	488
35641	35642	35643	35647	×	494615	544	584
36751	36752	36753	36757	10652	494616	672	712

Porta [Alu]



					rozstup vŕtania C (mm)	dĺžka L (mm)
371989	37909	179439	157786	465922	96	108
371990	37880	37980	157787	465923	128	140
371991	37881	37981	157788	465924	160	172
371992	37882	37982	157789	465925	192	204
371993	37883	37983	157790	465927	224	236
371994	37884	37984	157791	465928	256	268
371995	37885	37985	157792	465929	288	300
371996	37886	37986	157793	465930	320	332
371997	37887	37987	157794	465938	384	396
371998	37888	179441	157795	465937	432	444
371999	37889	37989	157796	465931	448	460
372000	37890	37990	157797	465932	480	492
372001	37891	37991	157798	465933	544	556
389788	37893	37993	157800	465934	672	684
389789	37894	37994	157801	465935	736	748
389791	37895	37995	157802	465936	768	780

Wakano [Alu]

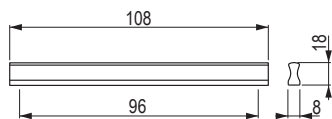

eloxovaný hliník

36333



čierna matná

494694

Hytech [Alu]

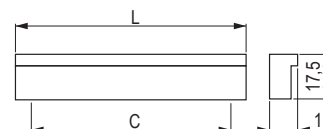

eloxovaný hliník

190523

rozstup vrtania
C (mm)

64

dĺžka
L (mm)

90

359390

96

120

359392

128

150

Jakoto II [Alu]

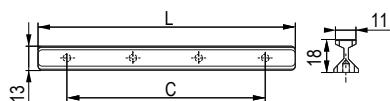
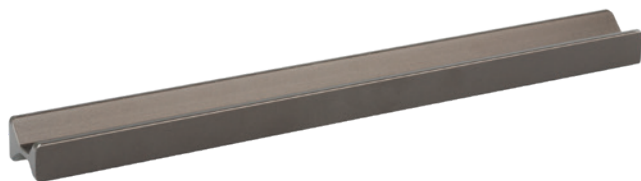

coffee
brúsená

544793



steel grey
brúsená

544795



čierna
brúsená

544789

rozstup vrtania
C (mm)

32

dĺžka
L (mm)

50

544794

544796

544790

128

150

x

x

544791

256

300

x

x

544792

1056

1200

Likano [Alu]

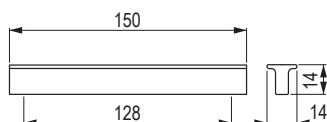

eloxovaný hliník

36332

Zuzana [Zamac]

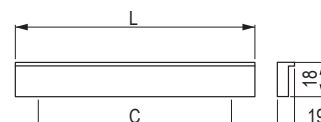

eloxovaný hliník

35900

rozstup vrtania
C (mm)

32

dĺžka
L (mm)

44

35898

128

140

Napa [Zamac]

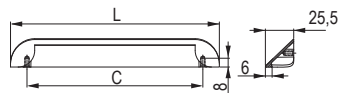

		rozstup vrtania C (mm)	dĺžka L (mm)
544826	544825	160	190

Acri [Zamac]

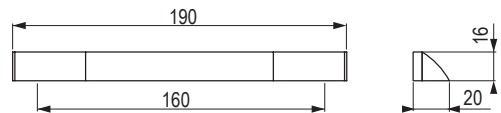

398580	398581	398582	398583	398584

Isola [Alu]

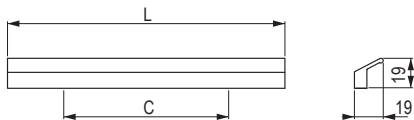

			rozstup vrtania C (mm)	dĺžka L (mm)
227293	227297	227301	96	116
227294	227298	227302	160	180
227295	227299	227303	224	244

Yuma [Zamac]

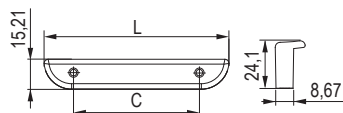

		rozstup vrtania C (mm)	dĺžka L (mm)
543767	543766	64	94
543769	543768	224	254

Envel [Zamac]

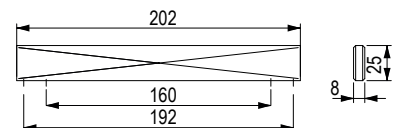

str. 11.33

482575	482574	482573

Sulky [Zamac]



staročierne

202828



starocín

202830

Halti [Zamac]

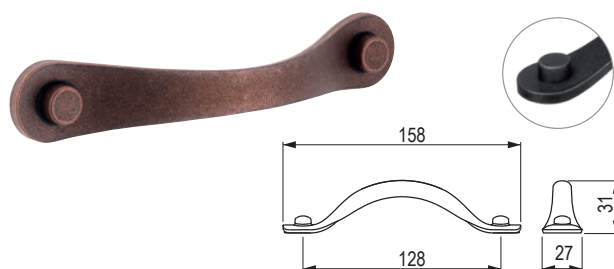

staročierne

351829



staromeď

351832

Kentucky [Zamac]

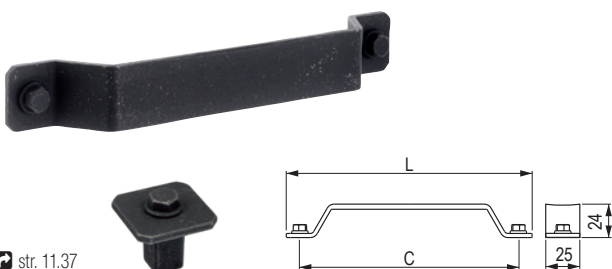

☞ str. 11.37



staročierne

202844



starocín

202846

rozstup vŕtania
C (mm)

160

dĺžka
L (mm)

180

202831

202843

192

212

Andrea [Zn]

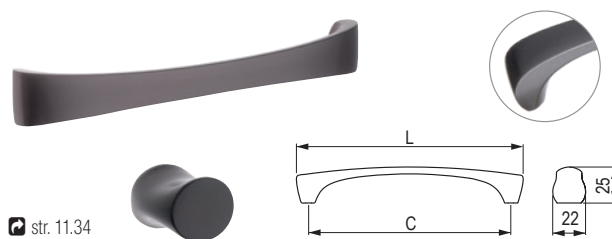

☞ str. 11.34



nikel tmavý
matný

351947

rozstup vŕtania
C (mm)

96

dĺžka
L (mm)

110

351948

128

142

351949

160

174

Kink [Zamac]

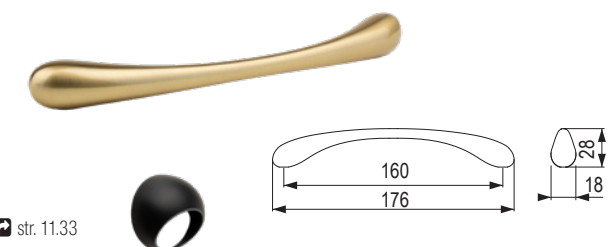

☞ str. 11.33



nikel brúsený

482585



tmavá zlatá brúsená

482584



čierna matná

482583

Besina [Zamac]

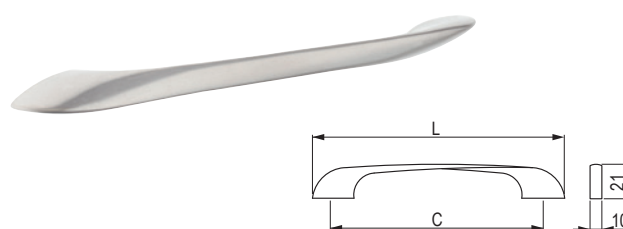

nikel matný

35471

rozstup vŕtania
C (mm)

96

dĺžka
L (mm)

121

35481

128

157



35491

160

190

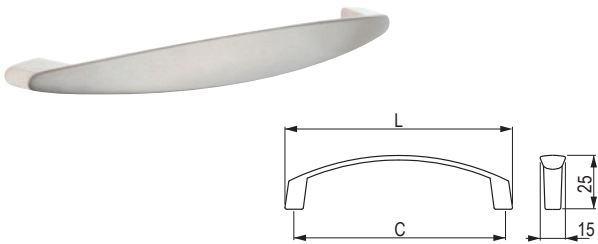
Nomina [Zamac]



		rozstup vrtania C (mm)	dĺžka L (mm)
			
chróm matný	nikel matný		
157534	157535	96	108
35232	35231	128	140

Iluna [Zamac]

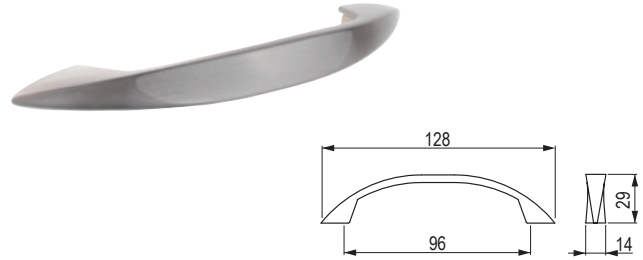

		
chróm matný	nikel brúsený	nikel matný
157527	157528	35301



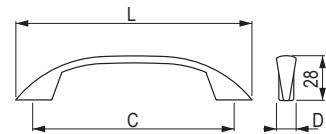



Ruona [Zamac]

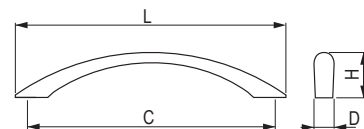

				rozstup vrtania C (mm)	dĺžka L (mm)	šírka D (mm)
						
nikel matný	chróm matný	chróm lesklý	čierna matná			
35451	35452	35453	35455	96	132	15
35461	35462	35463	×	128	164	16

Piombina [Zamac]



							rozstup vrtania C (mm)	dĺžka L (mm)	šírka D (mm)	výška H (mm)
										
nikel matný	chróm matný	chróm lesklý	zlatá lesklá	čierna matná	nikel brúsený	staromed' tmavá				
35251	35252	35253	35254	35255	157520	226980	96	127	12	24
35241	35242	×	×	35245	157521	×	128	164	14	28

Beta [Fe]

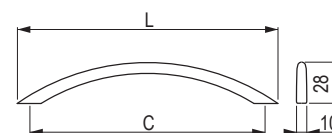

						rozstup vrtania C (mm)	dĺžka L (mm)
35011	35012	35013	35015	35019	35017	96	114
35021	35022	35023	35025	157522	157523	128	146

Anita [Zamac]

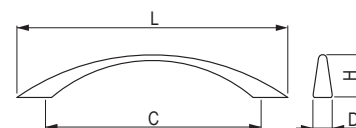

							rozstup vrtania C (mm)	dĺžka L (mm)	šírka D (mm)	výška H (mm)
35071	35072	35073	×	35075		×	64	81	9	23
35081	35082	35083	35084	35085	35089	157525	96	115	10	28
35091	35092	35093	×	35095	×	157526	128	164	11	28

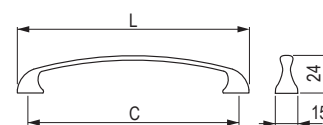

Uroso [Zamac]



						rozstup vrtania C (mm)	dĺžka L (mm)
35631	35632	35633	494594	494593	494604	96	112
35141	35142	×	494603	494602	494605	128	146

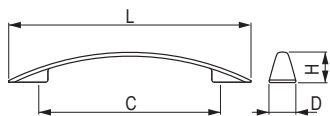

Unesa [Zamac]

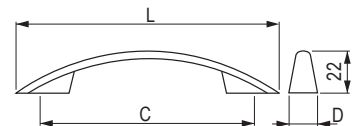

		rozstup vrtania C (mm)	dĺžka L (mm)	šírka D (mm)	výška H (mm)
157529	157530	96	141	16	23
35412	157531	128	186	21	24
157532	157533	160	216	21	24

Vali [Zn]



		rozstup vrtania C (mm)	dĺžka L (mm)	šírka D (mm)
226960	226963	96	140	15
226961	226964	128	174	16
226962	x	160	206	16

Palin [Zamac]

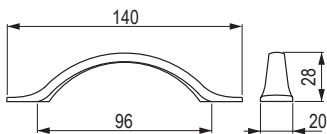

nikel matný

35561

Sema [Alu]

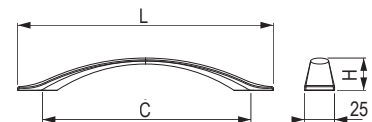

	rozstup vrtania C (mm)	dĺžka L (mm)	výška H (mm)
284053	128	181	27
284054	160	214	27
284055	256	309	29
284056	320	374	29

Kewina [Zamac]

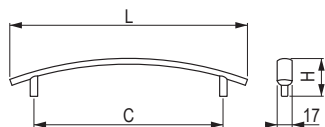

			rozstup vrtania C (mm)	dĺžka L (mm)	výška H (mm)
35161	35162	35163	96	124	25
35151	35152	35153	128	156	27

Sakita [Zamac]

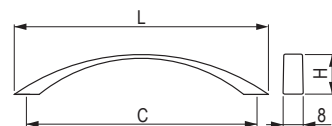

		rozstup vrtania C (mm)	dĺžka L (mm)	výška H (mm)
157556	157554	96	116	25
157723	157721	128	150	31

Pelena [Zn]

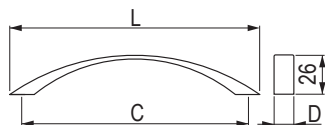

		rozstup vrtania C (mm)	dĺžka L (mm)	šírka D (mm)
157833	157825	128	140	19
157834	157826	160	174	20
37742	37741	192	228	20
157835	157827	224	257	20

Geneda [Zamac]

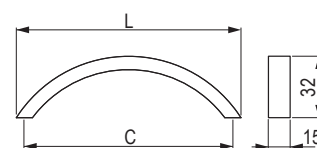

		rozstup vrtania C (mm)	dĺžka L (mm)
35112	157537	96	108
157539	157540	128	140

Malada [Zamac]

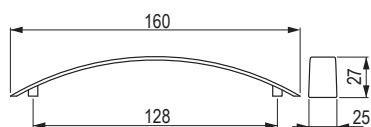

35832	35837

Fiona [Zamac]

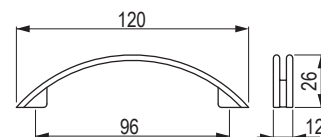

35041	35042	35043

Ruota [Zamac]



	rozstup vrtania C (mm)	dĺžka L (mm)	výška H (mm)
US008	32	48	26
US007	96	114	30
US006	128	145	30

Enza [Zamac]

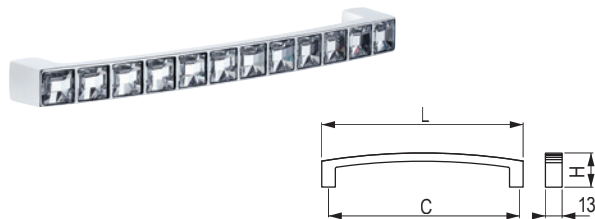

	rozstup vrtania C (mm)	dĺžka L (mm)	výška H (mm)
US004	96	107	22
US001	128	140	25

Kutta [Zamac]

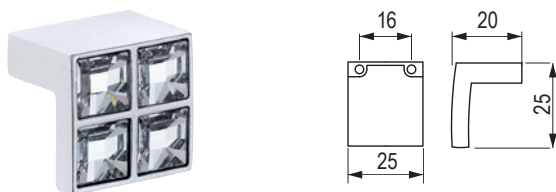

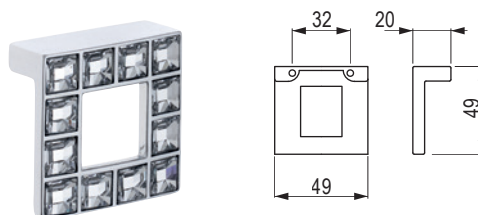

 chróm lesklý
US005

Kutta [Zamac]

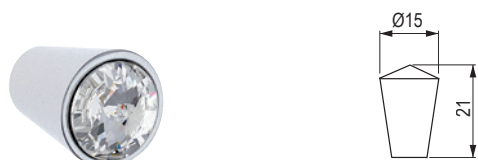

 chróm lesklý
US002

Ruota [Zamac]





 chróm lesklý
US011

Enza [Zamac]

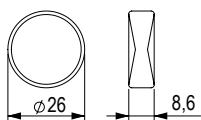

 chróm lesklý
US003

Blink [Zamac]



nikel brúsený

482578



tmavá zlatá brúsená

482577



čierna matná

482576

Envel [Zamac]

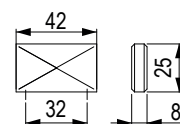

nikel brúsený

482572



tmavá zlatá brúsená

482570



čierna matná

482567

Tonk [Zn]

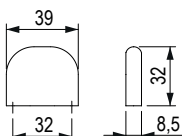

nikel brúsený

489334



zlatá brúsená

489335



čierna matná

489333

Kink [Zamac]

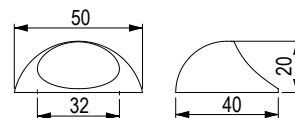

nikel brúsený

482582



tmavá zlatá brúsená

482581



čierna matná

482579

Mesa [Zamac]

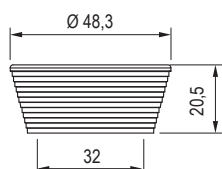

zlatá brúsená

543764



hnedá matná

543765



čierna matná

543763

Bella [Zamac]

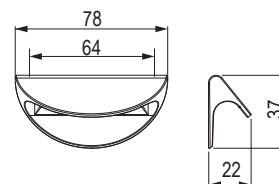

zlatá matná

396163



čierna matná

543785

Conic [Alu]

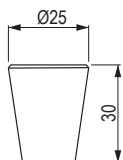

eloxovaný hliník

401557



zlatá matná

401558



hnedá matná

401556



čierna matná

401555

Iroko [Zn]

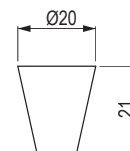

chróm matný

37251



nikel brúsený

37252

Mella [Alu]

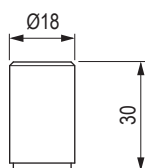

zlatá matná

396167



čierna matná

396166

Ota [Fe]

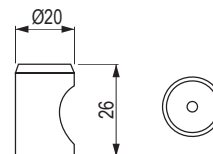

nehrdzavejúca oceľ brúsená

202884

Andrea [Zamac]

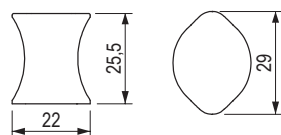

nikel tmavý matný

351946

Ruza [Zn]

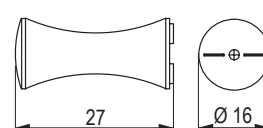

chróm matný

157290



chróm lesklý

157292



nikel brúsený

157291



čierna matná

157293

Jota [Zamac]

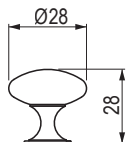

nikel brúsený	biela lesklá	nikel matný	chróm matný	chróm lesklý	zlatá lesklá	zlatá matná	čierna matná
35007	401575	35001	35002	35003	35004	494606	35005

Evan [Zamac]

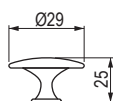

nikel matný	chróm matný	chróm lesklý	čierna lesklá	čierna matná
401571	401572	401573	401574	401570

Marusa [Zamac]

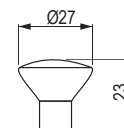

nikel matný	chróm matný	chróm lesklý
35171	35172	35173

Koby [Alu]

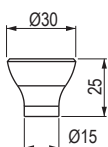
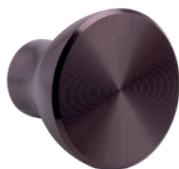

eloxovaný hliník	hnedá matná	čierna matná
401561	401560	401559



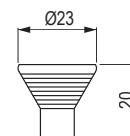

Galka [Zamac]

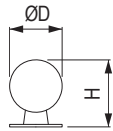

chróm lesklý	chróm matný
289671	289672

Tomic [Zamac]



				šírka D (mm)	výška H (mm)
35261	35262	35263	×	18	23
35271	35272	35273	35274	25	32

Boise O [Zamac]

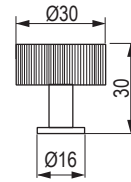

tmavá zlatá brúsená

544828



čierna matná

544827

Boise T [Zamac]

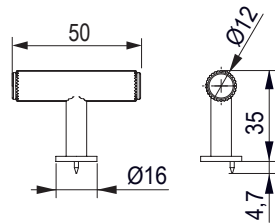

tmavá zlatá brúsená

544830



čierna matná

544829

Joliet [zamac/alu]

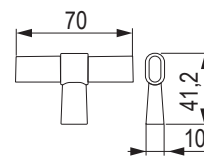
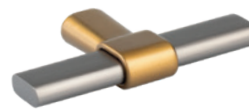

champagne bronze

547173



steel grey/čierna matná

547175



champagne bronze /steel grey

547174

Peblo [PWC]

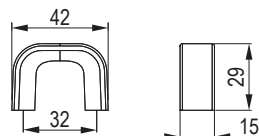

earth

543772



beton

543771

Recife II [Zamac]

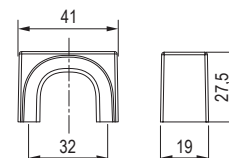

nikel brúsený

543776



hnedá matná

543777



čierna matná

543775

Hrazda [Fe/Alu]

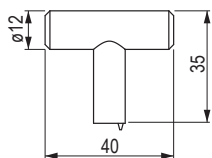

nikel matný

402377



chróm matný

402378



chróm lesklý

402379



nikel brúsený

402380



eloxovaný hliník

402381

Peca [Zn]

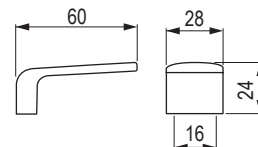

chróm lesklý/
imitácia nehrdzavejúcej ocele

246019



chróm lesklý/
biela matná

246011

Tinto [Zamac]

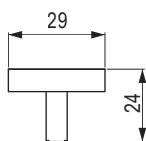

chróm matný

36313



chróm lesklý

36314

Prisma [Alu]

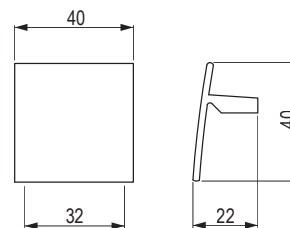

chróm matný

42016



imitácia nehrdzavejúcej ocele

42017

Kentucky [Zamac]

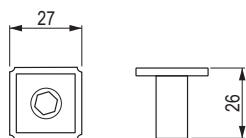

staročierna

351834



starocín

351836

Frame [Zamac]

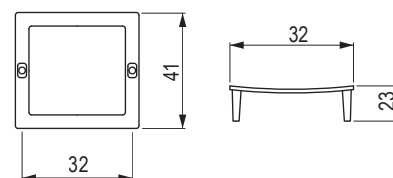

imitácia nehrdzavejúcej ocele

42096



čierna matná

396168

Menfi [Zamac]

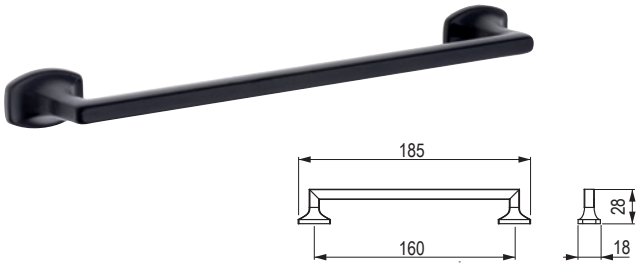

čierna matná

400314

Menfi [Zamac]

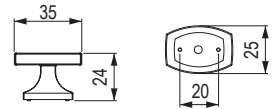

čierna matná

400316

Tomo [Zn]

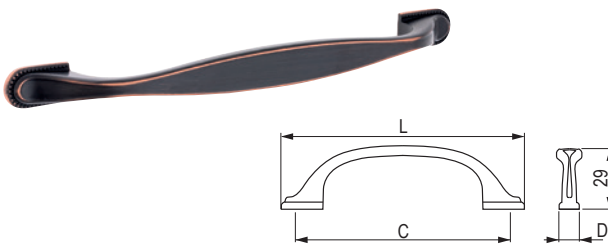

starocín
brúsený

226919

226921



staromeď
tmavá

226920

226922

rozstup
vrtania
C (mm)

96

160

dĺžka
L (mm)

132

204

šírka
D (mm)

14

16

Tomo [Zn]

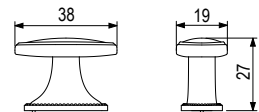

starocín
brúsený

226917



staromeď
tmavá

226918

Victoria [Zamac]

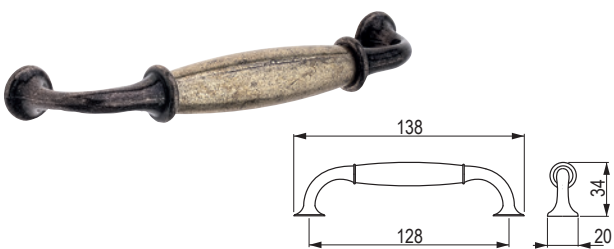

staročierna

42103



starobronz

157685

Victoria [Zamac]

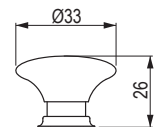

staročierna

42104



starobronz

157684

Turia [Zn]

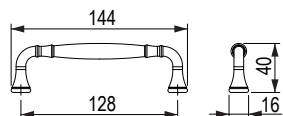

nikel brúsený

494695



starozlatá

494710



čierna matná

494709

Turia [Zn]

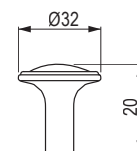

nikel matný

157300



chróm matný

157301



nikel brúsený

157302



chróm lesklý

157303



starozlatá

157304



čierna matná

494679

Rustik [Zamac]

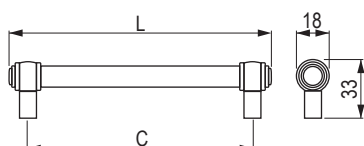

starozlatá

296149



starocín brúsený

296156

rozstup vŕtania
C (mm)

128

dĺžka
L (mm)

149

296150

296157

160

181

296154

296161

320

341

Rustik [Zamac]

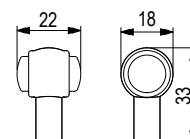

starozlatá

296164



starocín brúsený

296165

Country [Zamac]

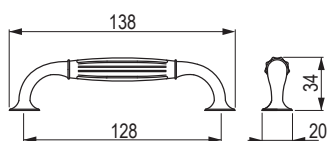

starozlatá/
porcelán béžový

157681



starobronz/
porcelán béžový

42100

Country [Zamac]

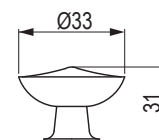
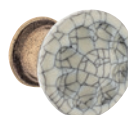

starobronz/
porcelán béžový

42102



starozlatá/
porcelán béžový

157679

Gipa [Zamac]

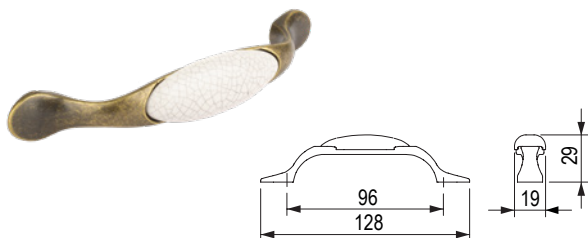

starozlatá/porcelán biely

309009



starozlatá/porcelán popraskaný

309010

Gipa [Zamac]

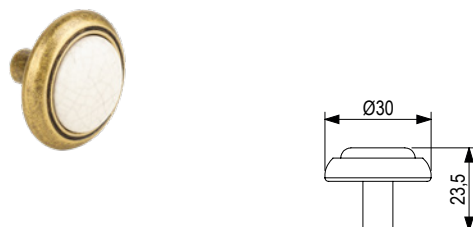

starozlatá/porcelán biely

309013



starozlatá/porcelán popraskaný

309012

Sara [Zamac]

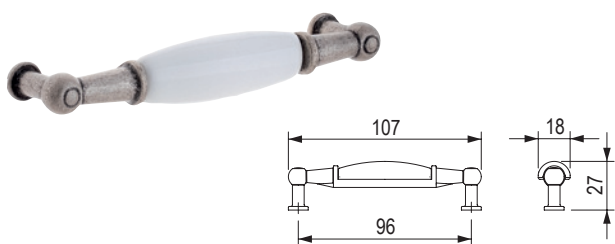

starocín/
porcelán biely

288823



starozlatá/
porcelán biely

309006

Sara [Zamac]



starocín/
porcelán biely

288820



starozlatá/
porcelán béžový

288821

Margarita [Zamac]



starocín/
porcelán/motív

288805



starozlatá/
porcelán/motív

288808



starocín/
porcelán biely

288806



starozlatá/
porcelán béžový

288807



hnedá/
porcelán/motív

288809

rozstup vrtania
C (mm)

96

dĺžka
L (mm)

127

šírka
D (mm)

25

288800

288803

288801

288802

288804

128

159

26

Margarita [Zamac]

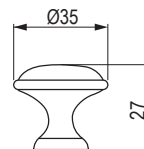

starocín/porcelán/motív

288810



starocín/porcelán biely

288813



starocín/porcelán biely

288811



starozlatá/porcelán béžový

288812



hnedá/porcelán/motív

288814

Vintage [Zamac]

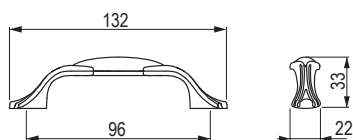

starozlatá/porcelán/motív

360611

Vintage [Zamac]

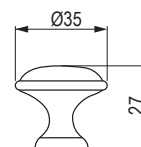

starozlatá/porcelán/motív

360609

Serena [Zamac]

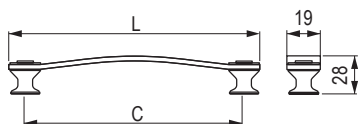

starozlatá

157283

rozstup vŕtania
C (mm)

128

dĺžka
L (mm)

147

Serena [Zamac]

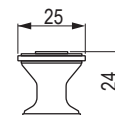

starozlatá

157285

Corsica [Zamac]

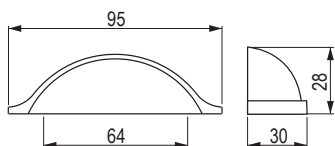

staročierna

202869

Loka [Zamac]

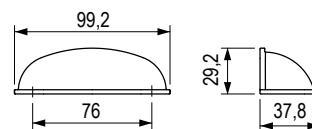

nikel brúsený

409056



zlatá matná

494174



čierna matná

494175

Cona [Zamac]

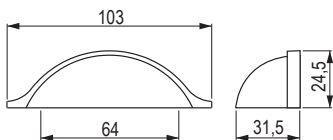

starozlatá

285004

Bold [Zamac]

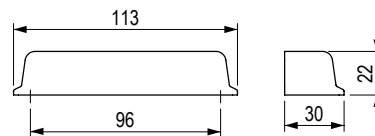

nikel brúsený

494195



čierna matná

494194

Panel F [Zamac]

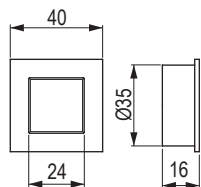

nikel brúsený

401584

Ring F [Zamac]

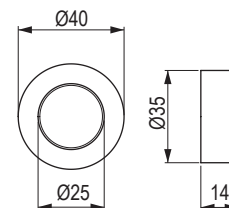

nikel brúsený

401588

Kaniva [Zamac]

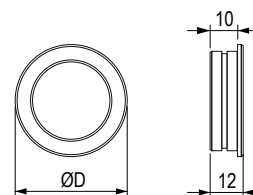

nikel matný

35531

x



chróm matný

35532

35542



chróm lesklý

35533

x



čierna matná

482746

482745

dĺžka
D (mm)

40

50

rozmery zahĺbenia
(frézovania) (mm)

35 × 35 × 10

42 × 42 × 10

Dunk [Zamac]

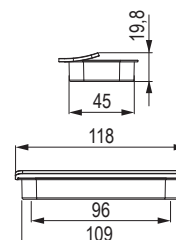

zlatá brúsená

543761



hnedá matná

543762



čierna matná

543760

rozmery zahĺbenia
(frézovania) (mm)

109 × 45 × 13,5

Avoca [Zn]

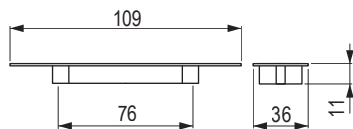

Model určený primárne pre posuvné dvere.

		rozmery zahĺbenia (frézovania) (mm)
chróm matný	nikel matný	
37771	37773	82 × 26,5 × 9

Anetta [Alu]

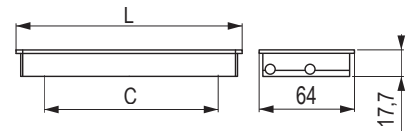

	rozstup vrtania C (mm)	dĺžka L (mm)	rozmery zahĺbenia (frézovania) (mm)
37870	96	120	114 × 57,5 × 14,5
37871	128	150	144 × 57,5 × 14,5

Shellby [Zamac]



			zahĺbenie (frézovanie) (mm)
nikel brúsený	starobronz	čierna matná	
398092	398094	398095	107 × 31 × 12,5

Nave [Alu]



		rozstup vrtania C (mm)	dĺžka L (mm)	rozmery zahĺbenia (frézovania) (mm)
225013	225017	96	106	101 × 36 × 11
225014	225018	160	170	166 × 36 × 11

Misura [Zamac]

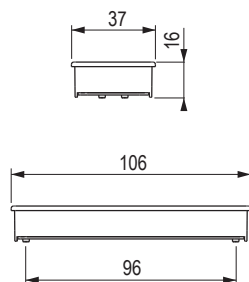

	zahĺbenie (frézovanie) (mm)
506047	103 × 34 × 14

Carpi [Zamac]

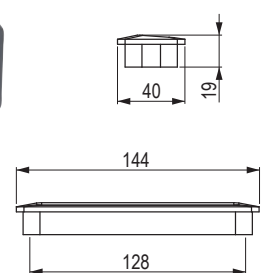

		zahĺbenie (rozmery frézovania) (mm)
400311	400312	137 × 32 × 13

Gliss [Zamac]

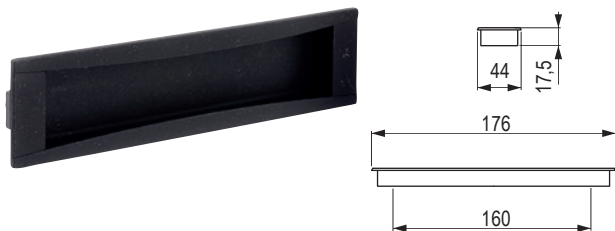

Model určený primárne pre posuvné dvere.

		rozмеры zahĺbenia (frézovania) (mm)
staročierna	starocín	
351940	351941	172 × 39 × 14

Madrid [Zamac]

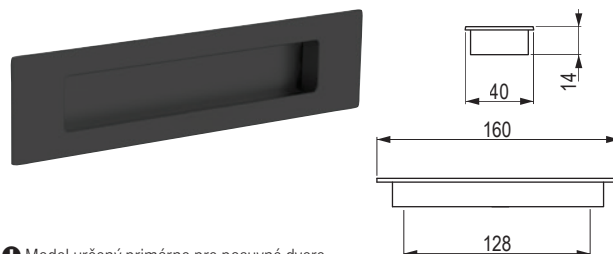

Model určený primárne pre posuvné dvere.

		rozмеры zahĺbenia (frézovania) (mm)
strieborná	čierna matná	
36334	482586	142,6 × 30 × 12

Rulida [Alu]

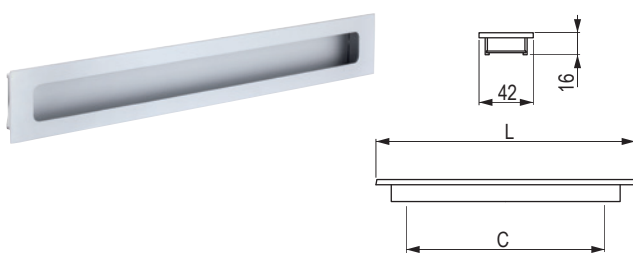

	rozstup vrtania C (mm)	dĺžka L (mm)	rozмеры zahĺbenia (frézovania) (mm)
eloxovaný hliník			
37006	128	145	136 × 33 × 14
37007	256	278	267 × 33 × 14

Orinoco [Zn]

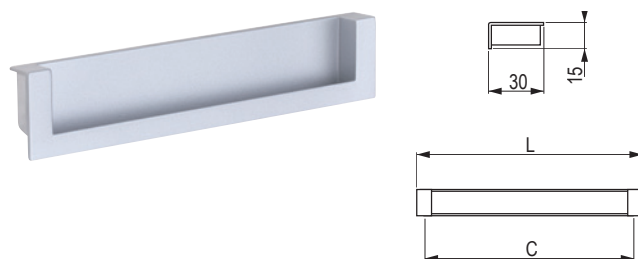

	rozstup vrtania C (mm)	dĺžka L (mm)	rozмеры zahĺbenia (frézovania) (mm)
strieborná			
157785	96	106	102 × 27 × 11
37201	128	138	134 × 27 × 11

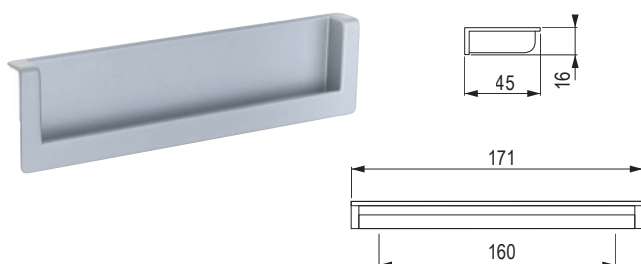

Rapid [Zamac]

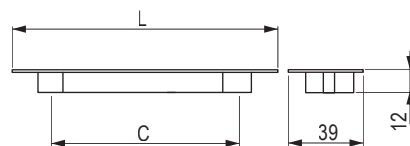

	rozмеры zahĺbenia (frézovania) (mm)
strieborná	
215529	167 × 40 × 12,5

Pesara [Zn]



		rozstup vrtania C (mm)	dĺžka L (mm)	rozмеры zahĺbenia (frézovania) (mm)
157782	157783	96	107	102 × 28 × 10
157781	37781	128	139	135 × 28 × 10

Malena [Alu]

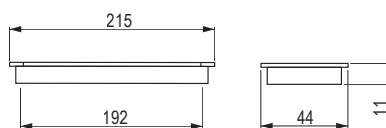
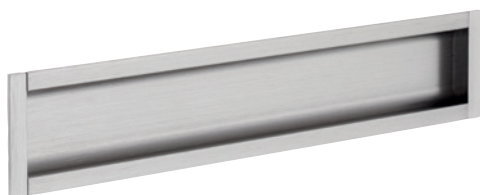

❗ Model určený primárne pre posuvné dvere.





Úchytka Malena je možné vďaka malej hrúbke použiť na posuvné dvere hrúbky 18 mm.

	rozмеры zahĺbenia (frézovania) (mm)
226998	209 × 38 × 9

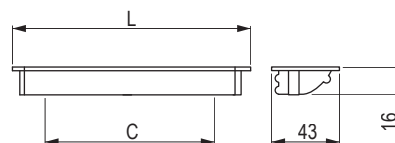

Concava [Zamac]



		rozstup vrtania C (mm)	dĺžka L (mm)	rozмеры zahĺbenia (frézovania) (mm)
37332	37333	96	109	103 × 36 × 14
157777	157778	128	140	137 × 36 × 14
37192	37193	160	171	167 × 36 × 14

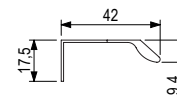
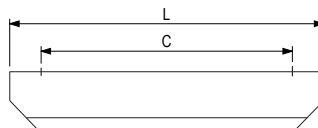



Lori II [Alu]

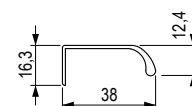
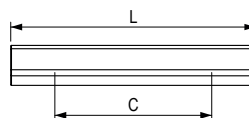

				
imitácia nehrdzavejúcej ocele	tmavá zlatá brúsená	čierna brúsená	rozstup vŕtania C (mm)	dĺžka L (mm)
544802	544797	544807	64	80
544803	544798	544808	160	200
544804	544799	544809	256	350
544805	544800	544810	480	500
544806	544801	544811	1056	1200



Nary [Alu]



					
coffee matná	imitácia nehrdzavejúcej ocele	čierna matná	antracit	rozstup vŕtania C (mm)	dĺžka L (mm)
544784	456882	456876	460523	32	50
x	456883	456877	460524	64	100
544785	456884	456878	460525	160	200
x	456885	456879	460526	256	300
544786	456886	456880	460527	352	400
x	456887	456881	460528	480	500
x	544788	544787	x	1056	1200

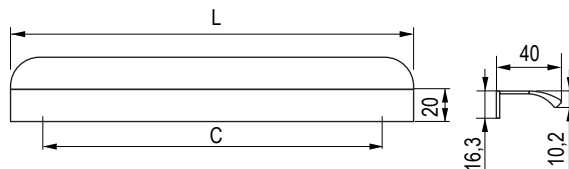





Bowie [Alu]

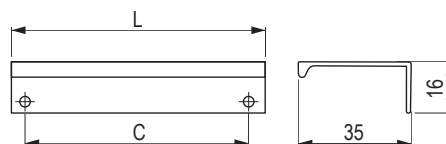
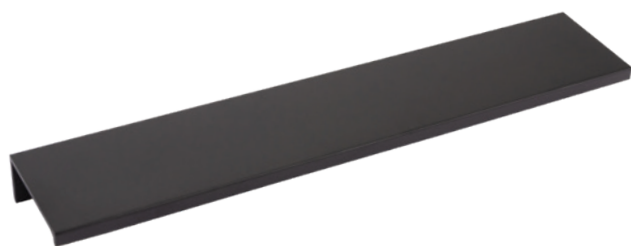

				
coffee brúsená	tmavá zlatá brúsená	čierna brúsená	rozstup C (mm)	dĺžka L (mm)
544766	544772	544778	32	50
544767	544773	544779	64	100
544768	544774	544780	160	200
544769	544775	544781	256	350
544770	544776	544782	480	500
544771	544777	544783	1056	1200



Lucata [Alu]



							
biela matná	chróm lesklý	imitácia nehrdzavejúcej ocele	eloxovaný hliník	zlatá brúsená	čierna matná	rozstup vŕtania C (mm)	dĺžka L (mm)
360347	227265	227271	227276	474383	360352	32	52
360348	227266	227272	227277	474384	360353	64	84
360349	227267	227273	227278	474385	360354	96	116
360350	227269	227274	227279	474386	360355	160	180
360351	227270	227275	227280	474387	360356	320	340
354155	354158	354153	354152	474388	354154	480	500
x	x	494663	284334	x	494662	x	3000

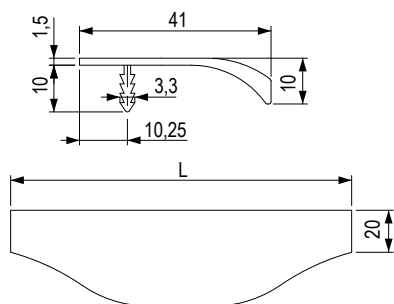

Sophia [Alu]



 imitácia nehrdzavejúcej ocele	 čierna matná	dĺžka L (mm)
494256	494266	146
494248	494261	196
494674	494673	246
494246	494263	296
494247	494264	346
494253	494265	396
494250	494262	446
494249	494267	496
368532	494666	546
494252	494268	596
494254	494269	696
494255	494270	796
494251	494271	896
494257	494272	996
494258	494273	1196

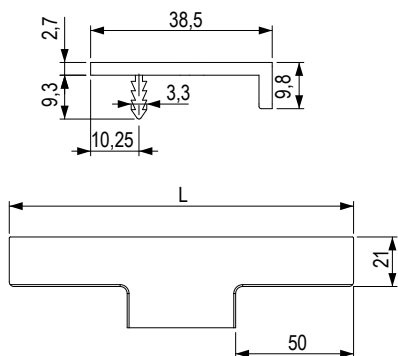



Ramara [Alu]

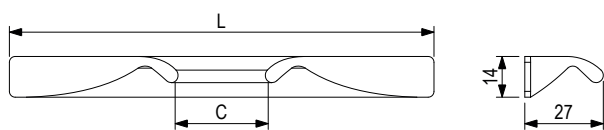

 imitácia nehrdzavejúcej ocele	 eloxovaný hliník	 čierna brúsená	dĺžka L (mm)
244831	244834	366458	146
244832	244835	366459	196
487951	487953	487954	246
202816	244836	366460	296
202817	244837	366461	346
244833	244838	366462	396
202818	244839	366463	446
202819	244840	366464	496
494678	494677	494676	546
202820	244841	366465	596
487955	487956	487957	696
202821	244842	366466	796
202822	244843	366467	896
202823	244844	366468	996
202824	244845	366469	1196





Tende [Alu]

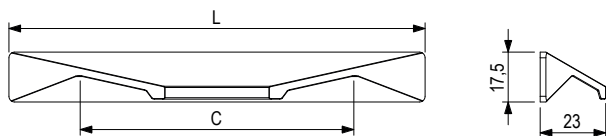

				rozstup vŕtania C (mm)	dĺžka L (mm)
456845	456858	456819	456832	16/32	146
456846	456859	456820	456833	32/64	196
456847	456860	456821	456834	128/160	296
456848	456861	456822	456835	160/224	346
456849	456863	456823	456836	192/256	396
456850	456866	456824	456837	224/288	446
456851	456867	456825	456838	288/352	496
456852	456869	456826	456839	384/448	596
456853	456870	456827	456840	480/544	696
456854	456871	456828	456841	576/640	796
456855	456872	456829	456842	672/736	896
456856	456873	456830	456843	768/832	996
456857	456874	456831	456844	960/1024	1196

Zoid [Alu]



				rozstup vŕtania C (mm)	dĺžka L (mm)
456762	456784	456799	456748	64/96	146
456770	456785	456800	456749	64/96	196
456771	456786	456801	456750	128/160	296
456772	456787	456802	456751	160/224	346
456775	456788	456803	456752	192/256	396
456776	456789	456804	456753	224 /288	446
456777	456791	456805	456754	288 /352	496
456778	456792	456806	456755	384 /448	596
456779	456793	456807	456756	480 /544	696
456780	456794	456808	456758	576 /640	796
456781	456795	456809	456759	672/736	896
456782	456796	456810	456760	768 /832	996
456783	456797	456811	456761	960 /1024	1196

Juvio [Alu]

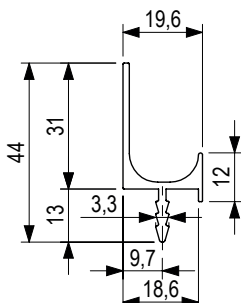
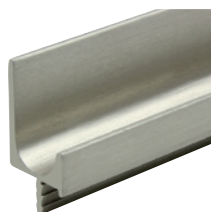

				dĺžka L (mm)	hrúbka lamina (mm)
506395	506406	×	×	297	18
506396	506407	×	×	347	18
506397	506408	×	×	397	18
506398	506409	×	×	447	18
506399	506410	×	×	497	18
506400	506411	×	×	597	18
506401	506412	×	×	697	18
506402	506413	×	×	797	18
506403	506414	×	×	897	18
506404	506415	×	×	997	18
506405	506416	×	×	1197	18
276815	276814	466366	466365	2900	18

Paolo [Alu]

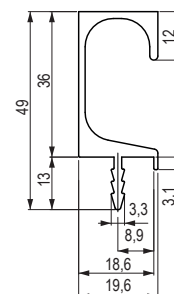
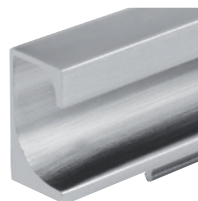

				dĺžka L (mm)	hrúbka lamina (mm)
506366	506384	×	×	297	18
506367	506385	×	×	347	18
506368	506386	×	×	397	18
506369	506387	×	×	447	18
506370	506388	×	×	497	18
506371	506389	×	×	597	18
506374	506390	×	×	697	18
506376	506391	×	×	797	18
506377	506392	×	×	897	18
506378	506393	×	×	997	18
506379	506394	×	×	1197	18
276820	276821	466371	466368	2900	18

Juvio L [Alu]

- Profil pre dvere s hrúbkou 19 – 20 mm.

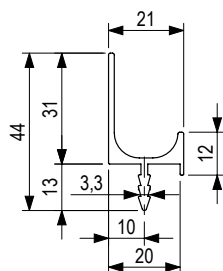

		dĺžka L (mm)	hrúbka lamina (mm)
494712	494711	2900	20

Paolo L [Alu]

- Profil pre dvere s hrúbkou 19 – 20 mm.

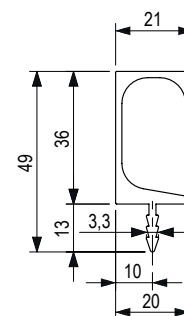

		dĺžka L (mm)	hrúbka lamina (mm)
494714	494713	2900	20

Fano [Alu]

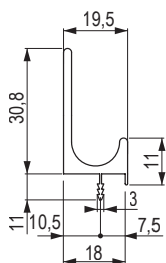

eloxovaný hliník	čierna matná	dĺžka L (mm)	hrúbka lamina (mm)
UC001	399431	2450	18

Ria [Alu]

- Profil na hranu skoseného čielka

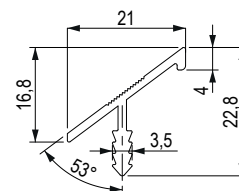

eloxovaný hliník	čierna matná	imitácia nehrdzavejúcej ocele	dĺžka L (mm)	hrúbka lamina (mm)
491992	491993	491994	2900	18

Lungo [Alu]

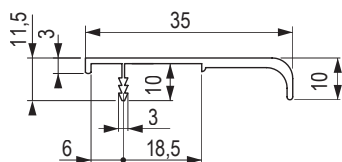

eloxovaný hliník	dĺžka L (mm)	hrúbka lamina (mm)
UC004	2950	18

Gola systém

System na bezúchytkové otváranie dverí. Zahŕňa profily horizontálne aj vertikálne (šatníkové skrine a kuchynské zostavy zabudované od zeme až po strop).



Horizontálny dvierkový „J“ profil.

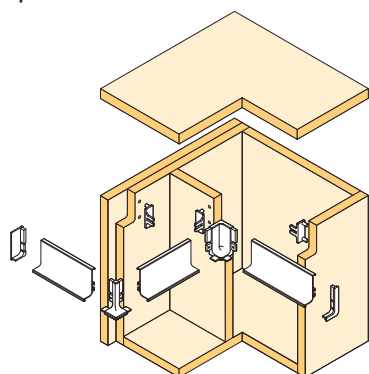

Horizontálny zásuvkový „C“ profil.

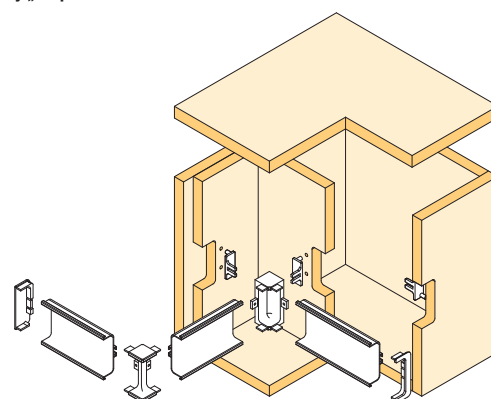





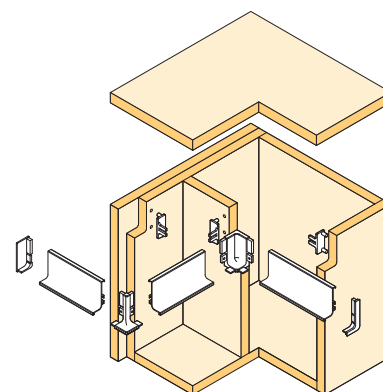
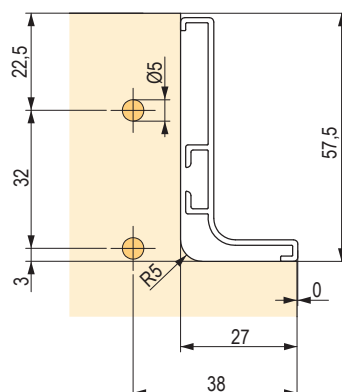
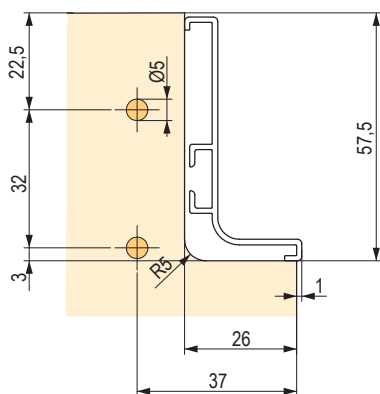

vertikálne profily (bočný a stredový)

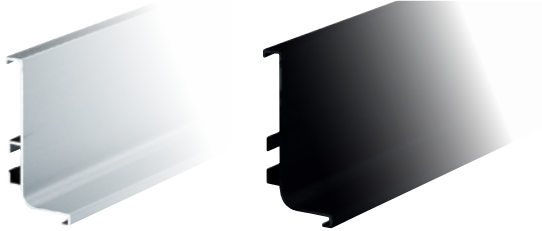
Horizontálne profily Gola



Dvierkový J profil 4 100 mm



				
imitácia nehrdzavejúcej ocele	eloxovaný hliník	biela pololesk	čierna matná	tmavá zlatá brúsená
228304	151631	284149	404389	502335

- profil pod pracovnú dosku
- uvedené montážne rozmery platia pre prípad, že profil bude presahovať 1 mm
- pokiaľ chcete mať profil zapustený v rovine, navýšte ich o 1 (37⇒38, 26⇒27)

Koncovky dvierkových profilov J

1.

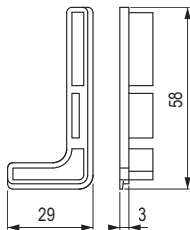

2.

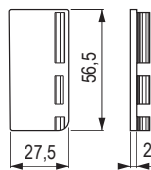



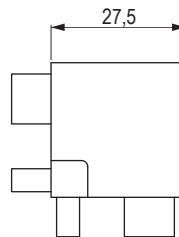



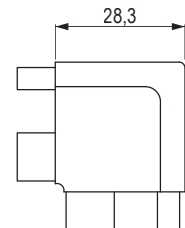

3.



4.



									
	strieborná	biela	čierna	imitácia nehrdzavejúcej ocele	eloxovaný hliník	čierna matná	tmavá zlatá brúsená	biela pololesk	
	PLASTOVÉ			KOVOVÉ					
1	otvorená koncovka	232861	289124	404394	228305	151632	404397	502337	x
2	uzavretá koncovka	284152	289121	404392	284150	284151	404399	502338	x
3	vonkajší roh	x	x	x	228306	151717	404393	502339	284153
4	vnútorný roh	x	x	x	228307	151718	404391	502340	284154

- súprava P+L koncovka

Zásuvkový C profil 4 100 mm



imitácia nehrdzavejúcej ocele	eloxovaný hliník	biela pololesk	čierna	tmavá zlatá brúsená
228308	151732	284155	404404	502336

- profil na použitie medzi zásuvkami nad sebou
- uvedenú montážne rozmery platia pre
 - prípad, že profil bude presahovať 1 mm
 - pokiaľ chcete mať profil zapustený v rovine, navýšte ich o 1 (37 ⇒ 38, 26 ⇒ 27)

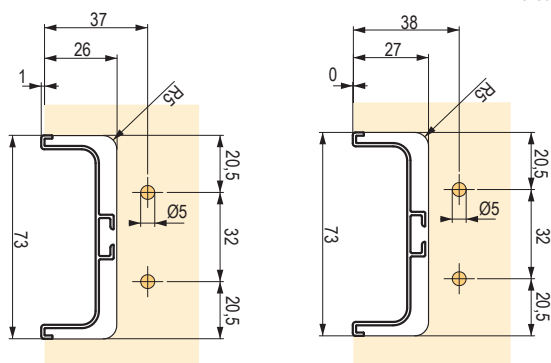

Koncovka zásuvkových profilov C

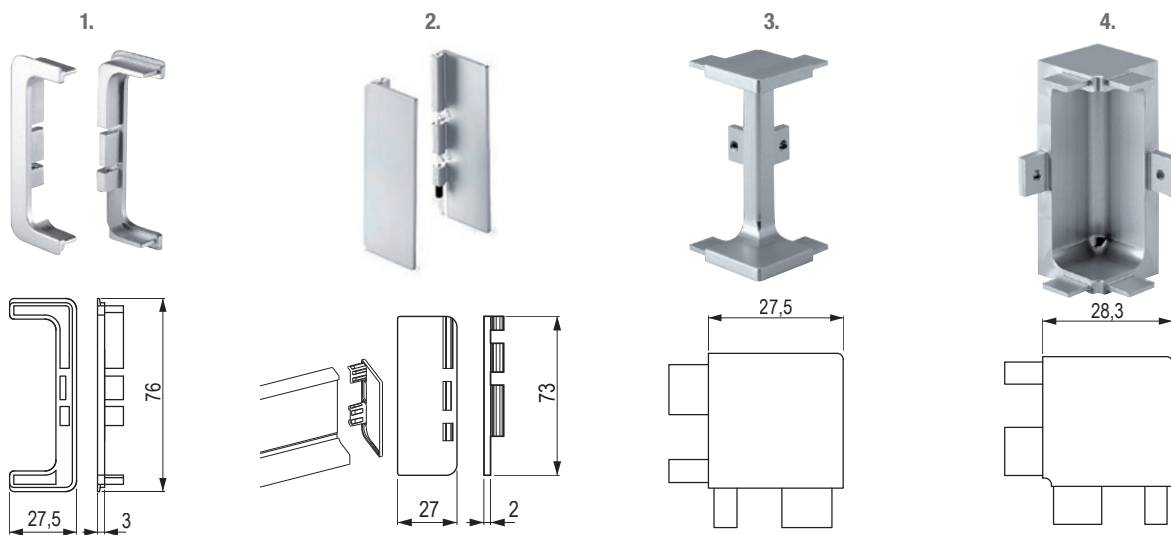

strieborná	biela	čierna	imitácia nehrdzavejúcej ocele	eloxovaný hliník	čierna matná	tmavá zlatá brúsená	biela pololesk

popis	PLASTOVÉ			KOVOVÉ				
1 otvorená koncovka	232862	289123	404414	228309	151785	404415	502341	×
2 uzavretá koncovka	284158	289122	404406	284156	284157	404417	502342	×
3 vonkajší roh	×	×	×	228310	151786	404413	502343	284159
4 vnútorný roh	×	×	×	228311	151821	404405	502344	284160

- súprava P+L koncovka
- používa sa len, pokiaľ profil nie je medzi bokmi skrinky

Príchyt zásuvkového a dvierkového profilu

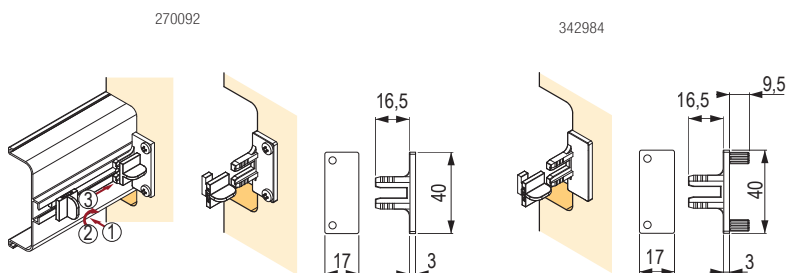

plast	plast, príchyt s tržmi
270092	342984

- súprava 2 príchytov na upevnenie profilu k bokom skrine
- sofistikované riešenie umožňujúce montáž profilu do už zostavenej skrinky

Dvierkový J profil 4 100 mm s LED

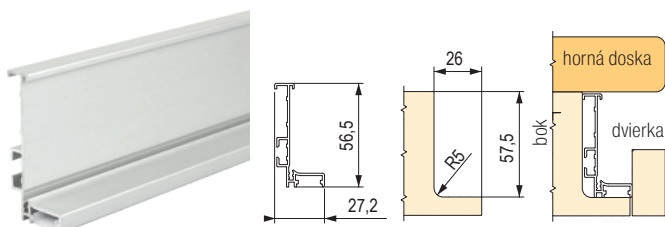

imitácia nehrdzavejúcej ocele	eloxovaný hliník	biela pololesk	čierna matná	tmavo zlatá brúsená
504523	504524	504525	504526	504527

- ❗ LED pásik nie je súčasťou dodávky a je nutné ho objednať samostatne.
- ❗ Je potrebné dokúpiť difúzor 504528

- profil pod pracovnú dosku
- uvedené montážne rozmery platia pre prípad, že profil bude presahovať 1 mm
- pokiaľ chcete mať profil zapustený v rovine, navýšte ich o 1 (37 ⇒ 38, 26 ⇒ 27)

Zásuvkový C profil 4 100 mm s LED

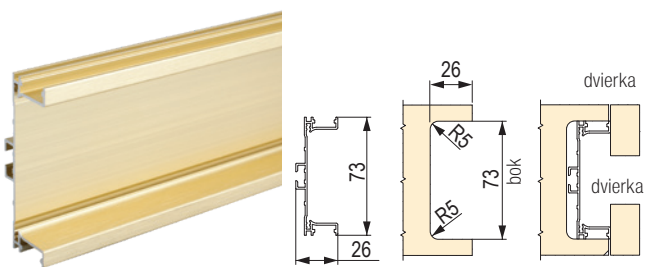

imitácia nehrdzavejúcej ocele	eloxovaný hliník	biela pololesk	čierna matná	tmavá zlatá brúsená
505493	505494	505495	505496	505485

- ❗ LED pásik nie je súčasťou dodávky a je nutné ho objednať samostatne.
- ❗ Je potrebné dokúpiť difúzor 504528

- profil na použitie medzi zásuvkami nad sebou
- uvedené montážne rozmery platia pre prípad, že profil bude presahovať 1 mm
- pokiaľ chcete mať profil zapustený v rovine, navýšte ich o 1 (37 ⇒ 38, 26 ⇒ 27)

Gola krytka (difúzor) pre dvierkový J a C profil s LED 4,1 m

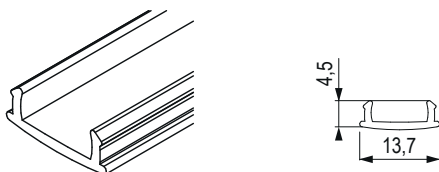

transparentný plast

504528

Vertikálne profily Gola pre bezúchytkové otváranie dverí skriň

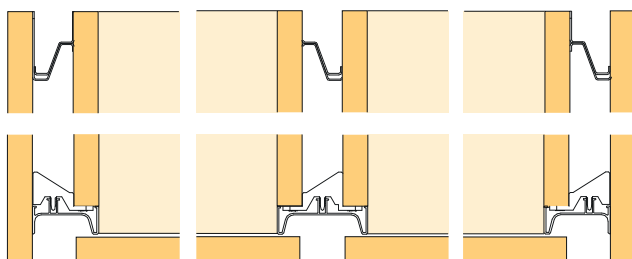

Šírka panelu



Krajný profil Snap on 2 700 mm

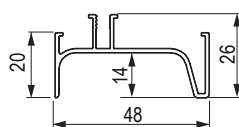
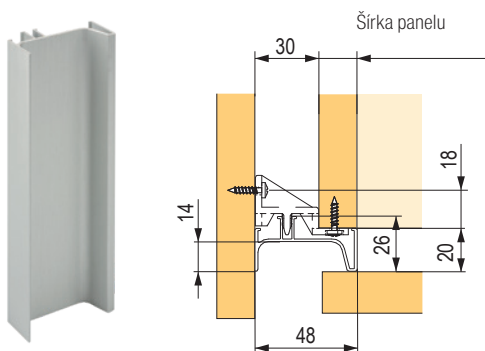

imitácia
nehrdzavejúcej
oceľe

502345



eloxovaný
hliník

502346



biela
pololesk

502348



čierna matná

502349



tmavá zlatá
brúsená

502350

Stredový profil Snap on 2 700 mm

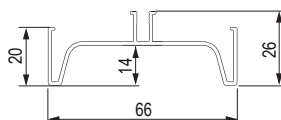
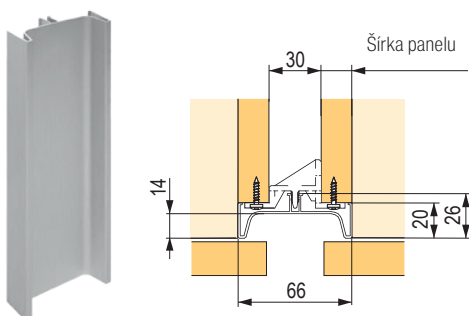

imitácia
nehrdzavejúcej
oceľe

502351



eloxovaný
hliník

502352



biela
pololesk

502353



čierna matná

502354



tmavá zlatá
brúsená

502355

Príslušenstvo k vertikálnym profilom Snap on

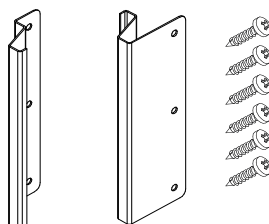

kód

popis

504520

kovový vymedzovací diel pre krajný a stredový profil

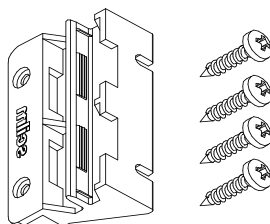

kód

popis

504521

príchyť plastový snap on pre krajný profil

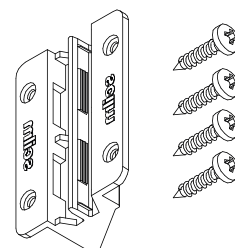

kód

popis

504522

príchyť plastový snap on pre stredový profi

• materiál: plast

Príslušenstvo k vertikálnym profilom Snap on

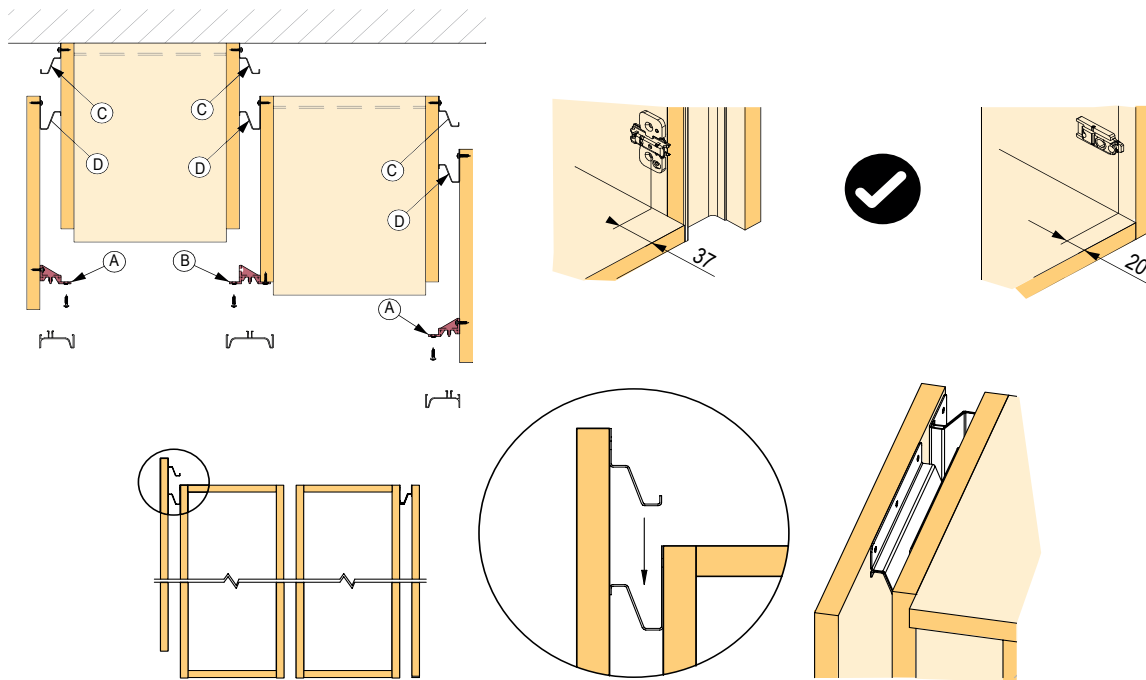

Gola profil 1275 pre vstavanú rúru

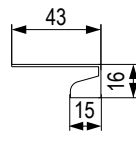
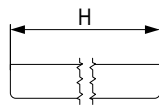





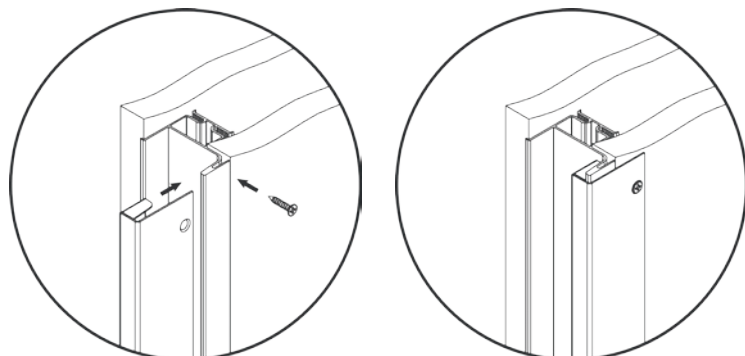

imitácia nehrdzavejúcej oceľ	eloxovaný hliník	biela pololesk	čierna matná	dĺžka (mm)
547280	529673	529674	529673	580

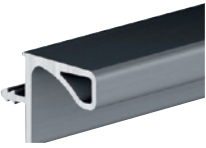
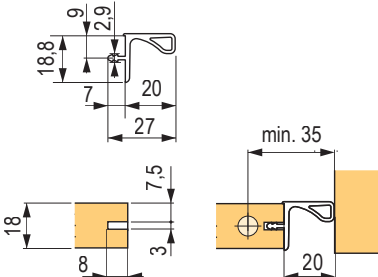
- ochrana pred teplom
- profil sa používa v kombinácii s vertikálnymi profilmi Snap on





Dvierkový profil 3 900 mm pre horné skrinky

				
imitácia nehrdzavejúcej ocele	eloxovaný hliník	biela lesklá	čierna matná	tmavá zlatá brúsená
228312	156848	360875	502356	502364

Dvierkový profil 3 900 m pre horné skrinky s tesnením

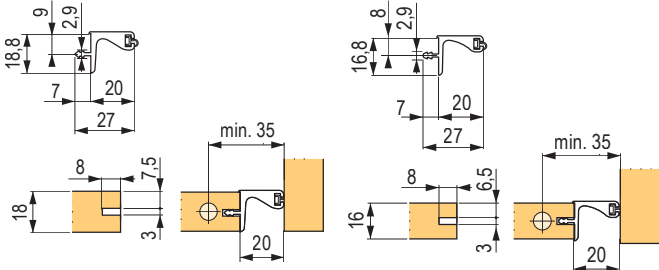
	eloxovaný hliník	pre hrúbku (mm)
366368		18
302379		16

Narážacie profily pre materiál s hr. 18 mm

CD0051



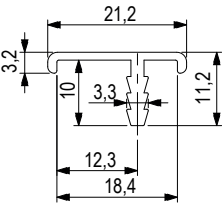

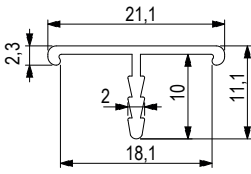
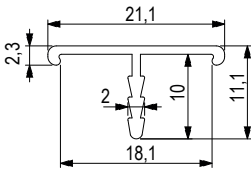

313756

	eloxovaný hliník	dĺžka L (mm)
313756		2 900

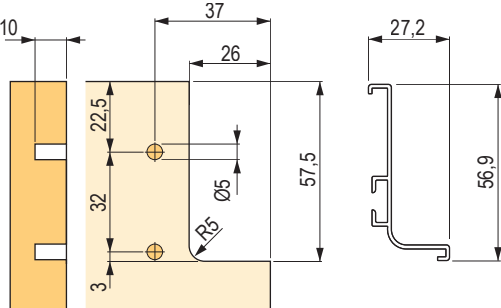
Dvierkový J profil II 2 900 mm (profil pod pracovnú dosku)

	imitácia nehrdzavejúcej ocele	313754
	eloxovaný hliník	313753

Zásuvkový C profil II 2 900 mm

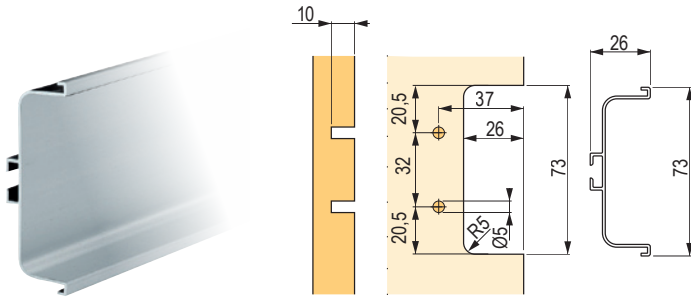

313752	313751

Príchytný zápusťový a dvierkový Ja C profilu

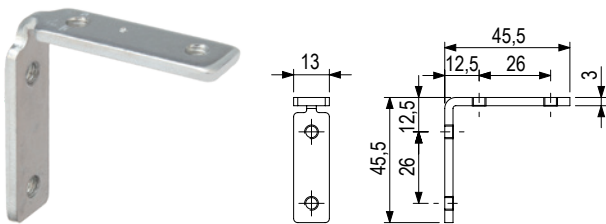

kov
313762

- súprava P+L koncovka
- používa sa len, pokiaľ profil nie je medzi bokmi skrinky

Koncovka zásuvkových profilov

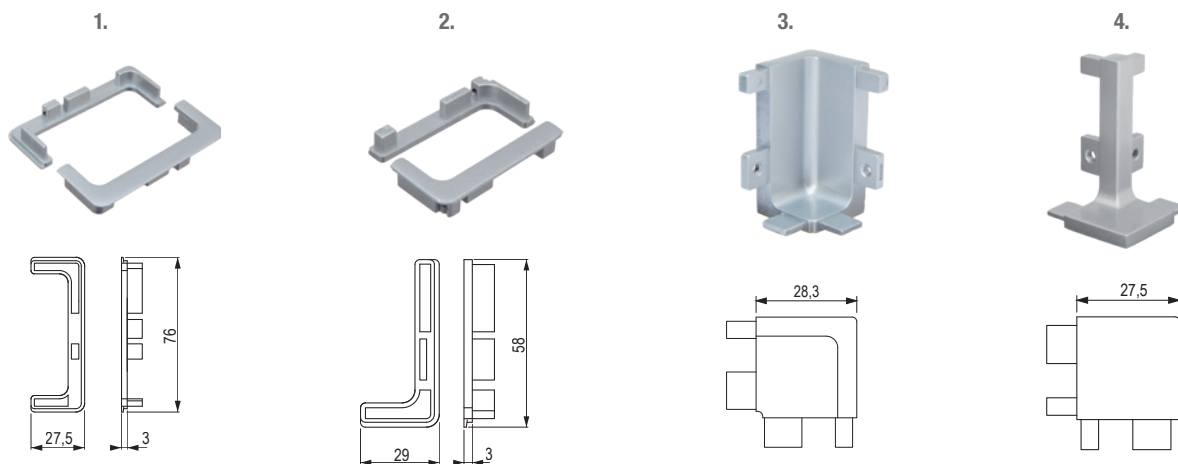

		eloxovaný hliník	popis
1	313758		otvorená koncovka
2	313757		otvorená koncovka
3	313759		vonkajší roh
4	313760		vnútorný roh

- súprava P+L koncovka
- používa sa len, pokiaľ profil nie je medzi bokmi skrinky

Berga

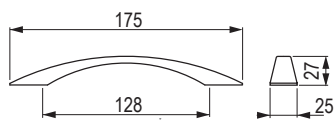

dub lakovaný

09459



buk lakovaný

09461

Beam

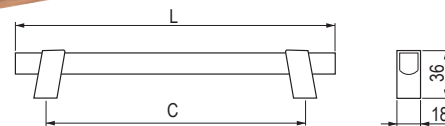

dub lakovaný

402330

502357

rozstup vrtania C (mm)

192

320

dĺžka L (mm)

242

370

Metra

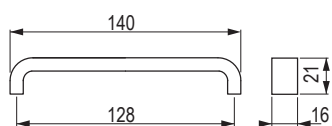

dub lakovaný

351899



buk lakovaný

351900

Rail

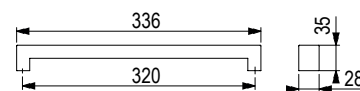

dub surový

500446



dub lakovaný

500447



jaseň surový

500448



jaseň lakovaný

500449

Lynn

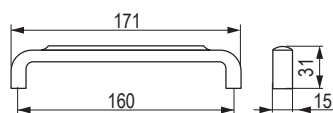

orech lakovaný

543785

rozstup vrtania C (mm)

160

dĺžka L (mm)

171

Boise

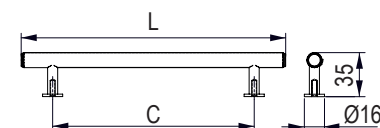

dub lakovaný / tmavá zlatá brúsená

549438

549440



dub lakovaný / čierna matná

549437

549439

rozstup vrtania C (mm)

160

320

dĺžka L (mm)

210

370

Mewo

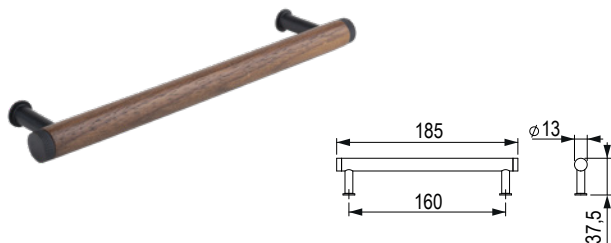

orech/čierna matná

497966



orech/zlatá matná

497967

Mewo



orech/čierna matná

497964



orech/zlatá matná

497965

Xin



dub surový	dub lakovaný	orech lakovaný	dub lakovaný/ čierna	dub lakovaný/biela	dub lakovaný/sivá	rozstup vŕtania C (mm)	dĺžka L (mm)
500434	500435	500436	x	x	x	32	60,5
500422	500423	500424	500425	500426	500427	192	225
500428	500429	500430	500431	500432	500433	996	1031

Lines

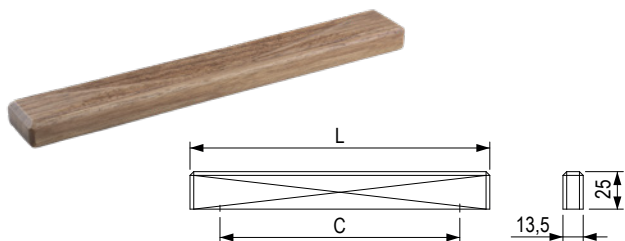

dub surový	dub lakovaný	orech lakovaný	rozstup vŕtania C (mm)	dĺžka L (mm)
500440	500441	500442	160	200
500443	500444	500445	480	520

Vasca

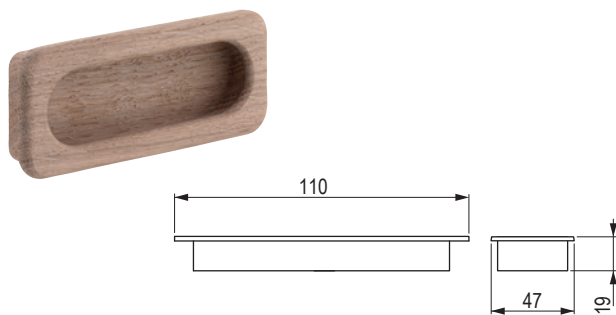

dub surový	buk surový	rozмеры zahĺbenia (frézovania) (mm)	hĺbka (mm)
351888	351889	100 × 40 × 13,5	13,5

Tine

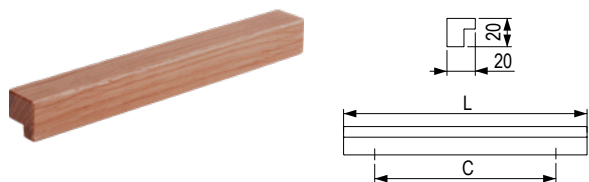

dub lakovaný	dub surový	rozstup vŕtania C (mm)	dĺžka L (mm)
497682	497685	128	172
497683	497686	320	365
497684	497687	960	1000

Chico

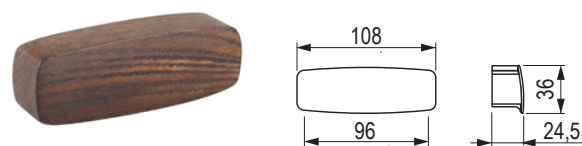

orech lakovaný

543770

Wave

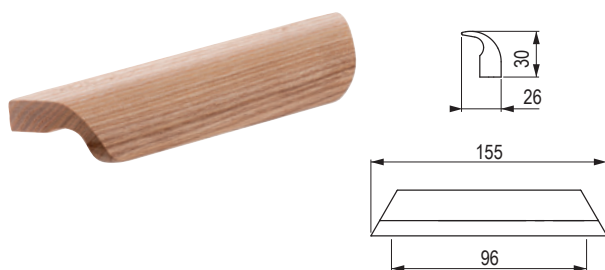

dub surový

404347



dub lakovaný

404348

Moku

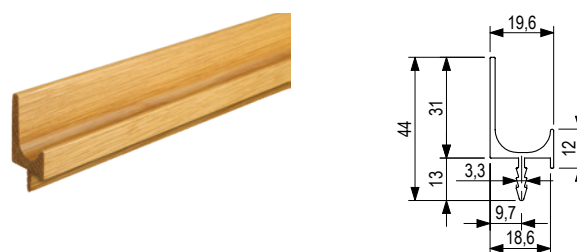

dub surový

547185



dub lakovaný

547184

dĺžka L (mm)

2400

Ames

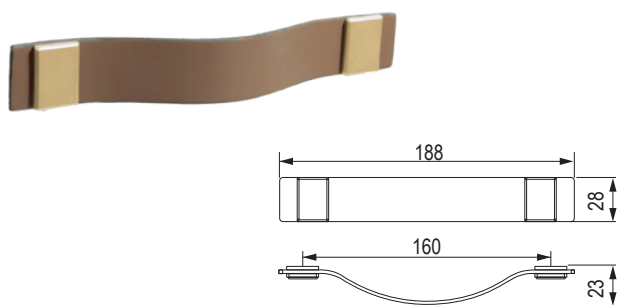

hnedá

547156

Ames

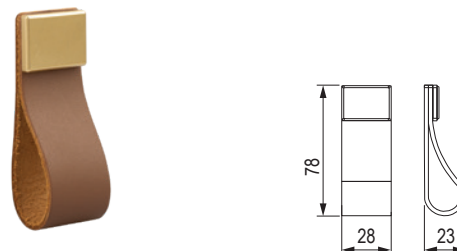

hnedá

547157

Square

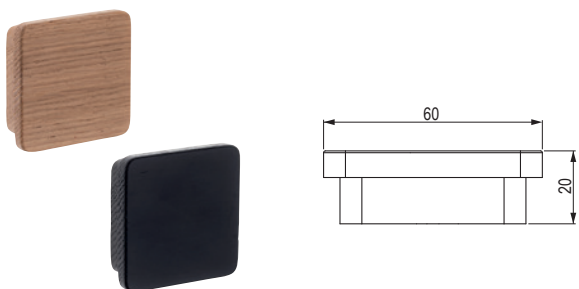

dub surový
404337



dub lakovaný
404338



buk čierna
404341

Hole

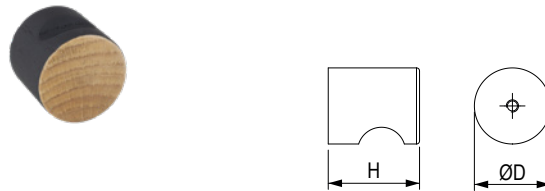

dub lakovaný/čierna

497674
497675

priemer D (mm)

25
40

výška H (mm)

30
35

Taper



dub surový
404331



dub lakovaný
404332



čierna
404335



buk surový
404333



buk lakovaný
404334



biela
404336

Jura



dub lakovaný
09413



borovica lakovaná
09414



buk lakovaný
09415

Jacek



dub lakovaný
09401



borovica lakovaná
09402



buk lakovaný
09403



buk surový
158699



borovica surová
158698

Adam



dub lakovaný	borovica lakovaná	buk lakovaný	buk surový	jelša lakovaná	borovica surová
09409	09410	09411	158704	09412	158703

Bala

Farbené drevo



tmavomodrý	fialový	olivový
212674	09491	09493

Sola

Farbené drevo



svetlomodrý	žltý
158717	158723

Cute

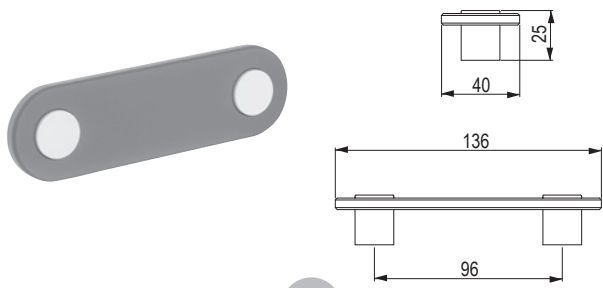

sivá/biela

405137

Cute



sivá/biela

405148

P431

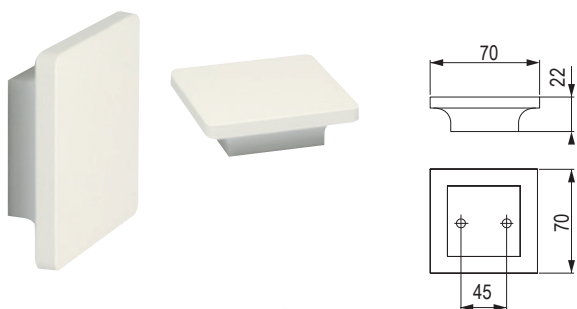

biela

265483

P439



biela

265486

Spaccata



hnedý povraz

351879

Spaccata





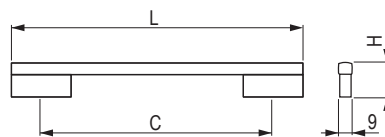

hnedý povraz

382066

Cana



				rozstup vrtania C (mm)	dĺžka L (mm)	výška H (mm)
ružová	zelená	biela	svetlomodrá			
303199	303203	303211	303207	128	152	30
303200	303204	303212	303208	160	200	30

Funga

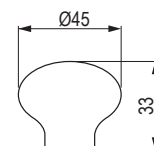

			
ružová	zelená	biela	svetlomodrá
303233	303234	303236	303235

Palla

Mäkčený plast

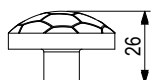
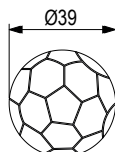

motív
198702

Bottone

Tvrdený plast

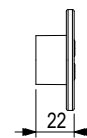
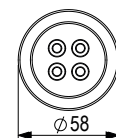

biela
351883



modrá
351884



ružová
351885

Into

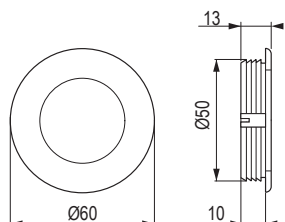

biela

405152



čierna

405154

Large

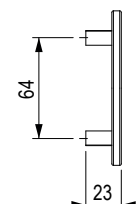
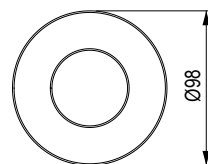

biela

405157



sivá

405158



ružová

405160



Filip [Stainless steel]

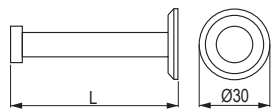

nehrdzavejúca oceľ brúsená

372855

352456

dĺžka
L (mm)

52

72

Element [Stainless steel]

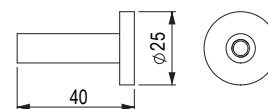

nehrdzavejúca oceľ
brúsená

484696



chróm lesklý

484697



zlatá brúsená

484700



čierna brúsená

484698

Balo [Zamac]

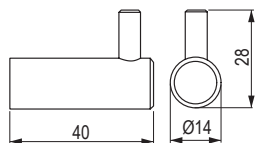

čierna matná

398940

Rudi [Zamac]

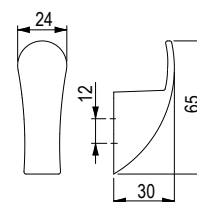

nikel brúsený

483279



tmavá zlatá brúsená

491190



čierna matná

483278

Troy [Zamac]

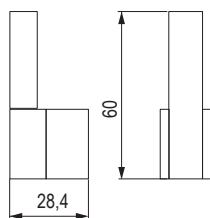

champagne bronz

547177



steel grey

547178



čierna brúsená

547176

Boise [Zamac]

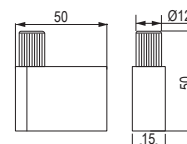

tmavá zlatá brúsená

547181



čierna matná

547180

Doris [Zn]

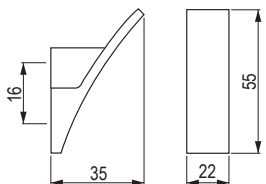

chróm matný

204687



nikel brúsený

204688



čierna matná

544822

Dyan [Zamac]

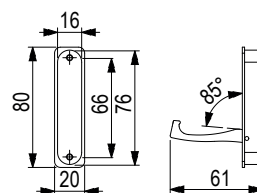

nikel matný

231588



chróm matný

231589

Rini [Zamac]

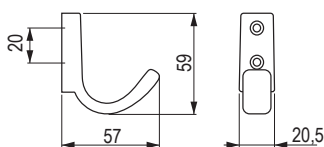

čierna matná

505995

Rini XL [Zamac]

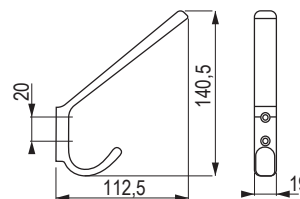

čierna matná

505996

Peri [Zamac]

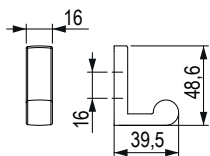

nikel brúsený

494191



čierna matná

494190

Peri XL [Zamac]

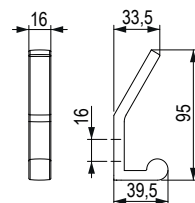

nikel brúsený

494193



čierna matná

494192

Pera [Zamac]

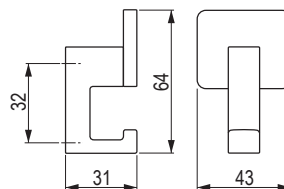

eloxovaný hliník

77812



nikel brúsený

77813



tmavá zlatá matná

399803



čierna matná

356378

Kara S [Zamac]

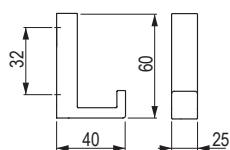

nikel brúsený

284988



chróm lesklý

284991



čierna matná

355732



biela lesklá

355729

Kara M [Zamac]

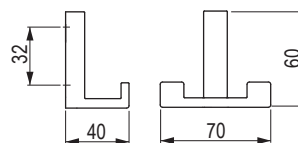

nikel brúsený

284989



chróm lesklý

284992



čierna matná

355731



biela lesklá

355728

Kara L [Zamac]

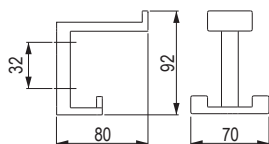

nikel brúsený

284990



chróm lesklý

284993



čierna matná

355730



biela lesklá

355727

Marell [Zamac]

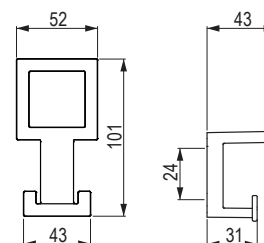

nikel brúsený

398005



čierna matná

398004

Gant [Zn]

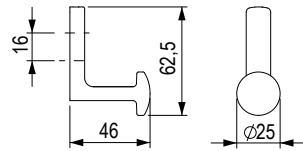

nikel brúsený

483282



čierna matná

483280

Gant XL [Zamac]

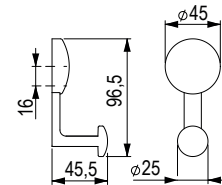

nikel brúsený

483285



čierna matná

483284

Dax [Zamac]

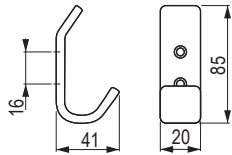

chróm matný

157327



nikel matný

157328

Iwo [Zamac]

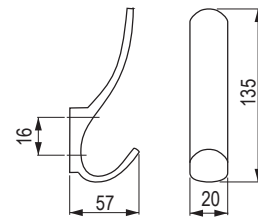

nikel matný

289683



chróm matný

289684

Ener [Zamac]

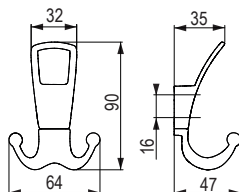

nikel brúsený

483276



čierna matná

483275

Ener XL [Zamac]

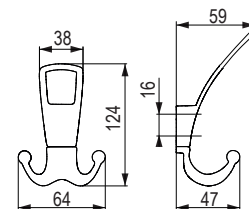

nikel brúsený

483274



čierna matná

483273

Cid [Zamac]

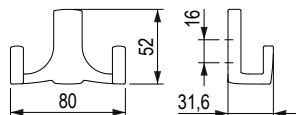

nikel brúsený

494171



čierna matná

494170

Cid XL [Zamac]

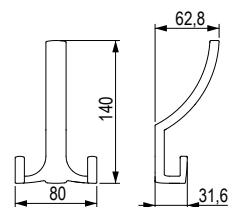

nikel brúsený

494173



čierna matná

494172

Marcel [Zamac]

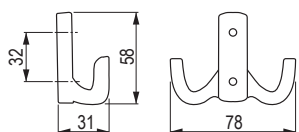

chróm lesklý

290153



chróm matný

290154



nikel matný

290155

Marcel XL [Zamac]

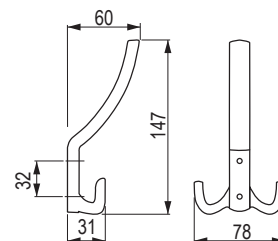

chróm lesklý

290150



chróm matný

290151



nikel matný

290152

Lugo [Zamac]

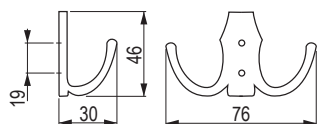

nikel matný

35591



chróm matný

35592



chróm lesklý

35593



zlatá lesklá

35594



čierna matná

35595

Lugo XL [Zamac]

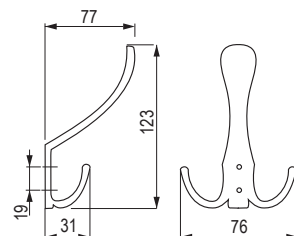

nikel matný

35581



chróm matný

35582



chróm lesklý

35583



zlatá lesklá

35584



čierna matná

35585

Muso [Zn]

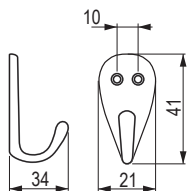

chróm matný

157333



nikel matný

157334



chróm lesklý

157335



čierna matná

544823

Lerico [Zn]

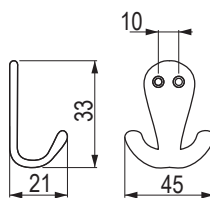

chróm matný

157330



nikel matný

157331



chróm lesklý

157332



čierna matná

544824

Livorno [Zamac]

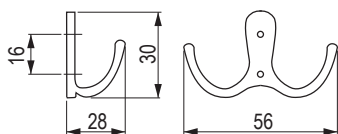

nikel matný

35611



chróm matný

35612



chróm lesklý

35613



čierna matná

35615

Rokos [Zamac]

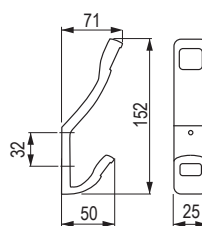

nikel matný

289681



chróm matný

289682

Darec [Zamac]

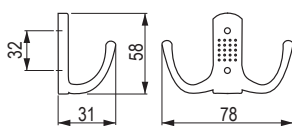

chróm lesklý

289679



chróm matný

289680

Darec XL [Zamac]

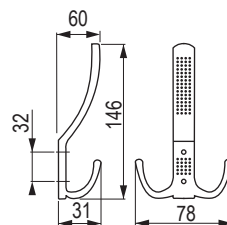

chróm lesklý

289677



chróm matný

289678

Murero [Zn]

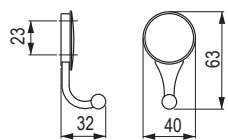

starozlatá
157317

Murero XL [Zn]

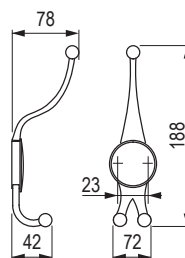

starozlatá
157319

Rubico [Zn]

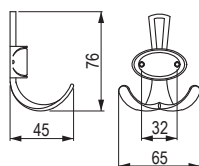

staročierna
157309



starozlatá
157310

Rubico XL [Zn]

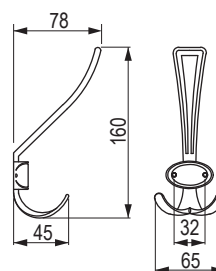

staročierna
157311



starozlatá
157312

Orio [Zamac]

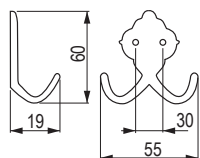

starozlatá
36769

Orio XL [Zamac]

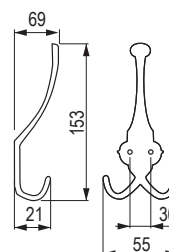

starozlatá
36768

Balo XL [Zamac]

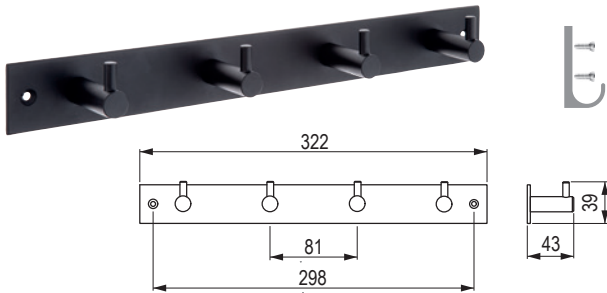

čierna matná

398939

Twist [Zamac]

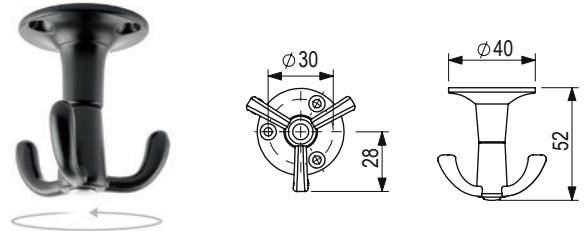

chróm matný

414103

čierna matná

414102

Xin

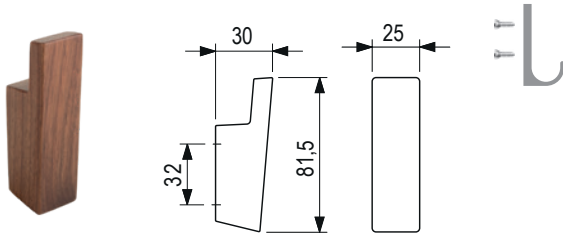

dub surový

500437

dub lakovaný

500438

orech lakovaný

500439

Extendo XL [Zamac]

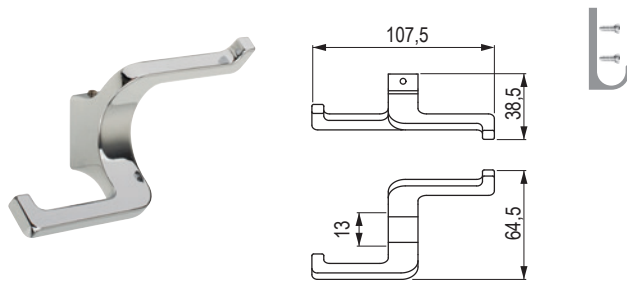

chróm matný

283968

nikel brúsený

283969

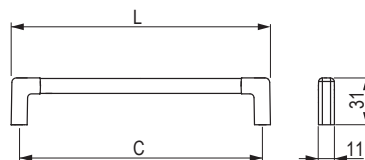

Vitruvio [Zamac]



			
antracit	zlatá matná	rozstup vŕtania C (mm)	dĺžka L (mm)
405059	405061	160	170,6
405060	405062	320	330,6

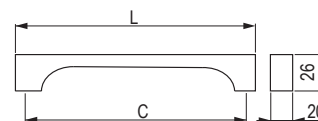

Lama [Zamac]

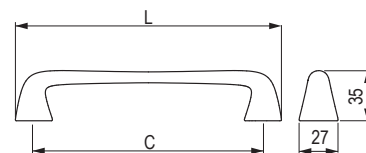

				
zlatá matná	hnedá matná	nikel tmavý	rozstup vŕtania C (mm)	dĺžka L (mm)
356243	356245	356247	160	170
356242	356244	x	320	330

Tonda [Zamac]



			
čierna silk touch	sivá silk touch	rozstup vŕtania C (mm)	dĺžka L (mm)
405046	405050	160	184,4
405047	405051	320	344,4

Torus [Zamac]

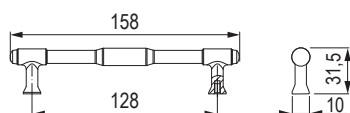

zlatá matná

541307



čierna matná

541309

Torus [Zamac]

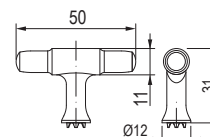

zlatá matná

541308



čierna matná

541310

Riva [Zamac]

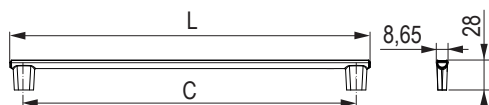

titanium

541315



čierna matná

541311

rozstup vŕtania
C (mm)

160

dĺžka
L (mm)

177

541316

541312

320

337

541318

541314

1088

1110

Riva [Zamac]

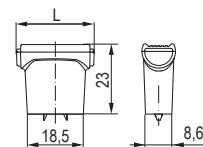

titanium

541317



čierna matná

541313

dĺžka L (mm)

26

Linea [Zamac]

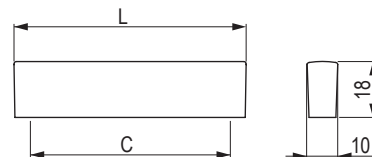

čierna silk touch

rozstup vŕtania
C (mm)

dĺžka
L (mm)

405070	32/64	76
405072	224/256	268

Brera [Zamac]

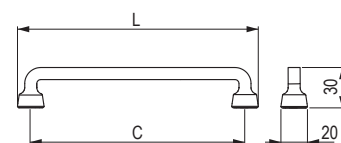

starobronz



čierna matná



zlatá
brúsená

rozstup vŕtania
C (mm)

dĺžka
L (mm)

356226	356229	405054	96	116
356225	356228	405055	160	180
356224	356227	405056	320	340

Defense [Zamac]

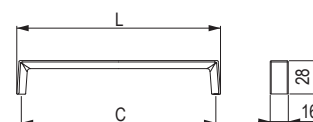

- odtiene farieb sa môžu vzájomne líšiť



starozlatá



čierna matná

rozstup vŕtania
C (mm)

dĺžka
L (mm)

356233	356235	160	167
356232	356234	320	327

Art Decó [Zamac]

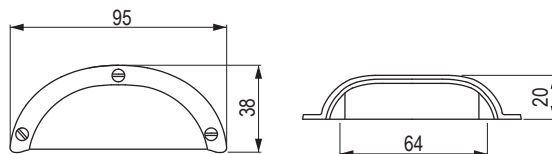

- odtíene farieb sa môžu vzájomne líšiť



efekt hrdze
356270



blue washed
356271

Viaggio [Zamac]

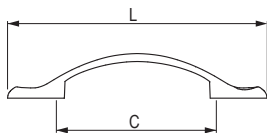
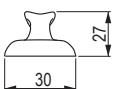

- odtíene farieb sa môžu vzájomne líšiť



washed stone

356261



efekt hrdze

356264

rozstup vrtania
C (mm)

96

dĺžka
L (mm)

156

356260

356263

128

187

Viaggio [Zamac]

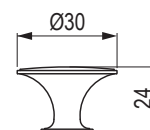

- odtíene farieb sa môžu vzájomne líšiť



washed stone

356262



efekt hrdze

356265

Sirius [Zamac]

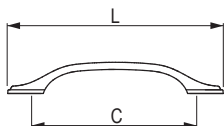

- odtíene farieb sa môžu vzájomne líšiť



efekt hrdze

356254



starocín

284267

rozstup
vrtania
C (mm)

96

dĺžka
L (mm)

142

šírka
D (mm)

21

výška
H (mm)

28

356253

284268

128

177

22

29

356252

284269

160

210

25

30

Columnae [Zamac]

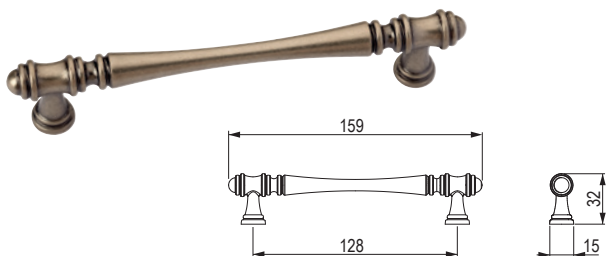

bronz

405063



starocín

405064



staromeď tmavá

405065

Columnae [Zamac]

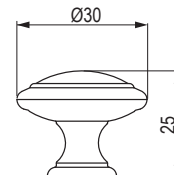

bronz

405066



starocín

405067



staromeď tmavá

405068

Macis [Zamac]

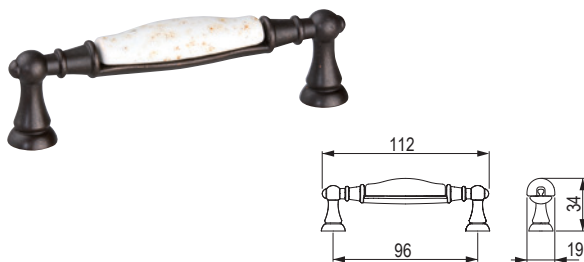

staromeď tmavá/porcelán biely

284279

Macis [Zamac]

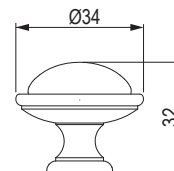

staromeď tmavá/porcelán biely

284280

Augusto [Zamac]

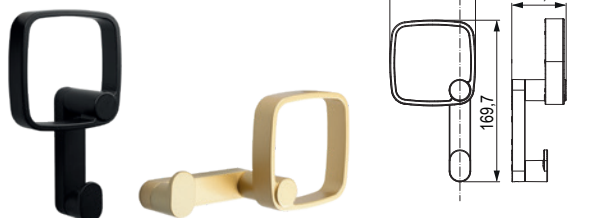

tmavá zlatá matná

541305



čierna matná

541304

Tiberio [Zamac]



čierna matná

541306

Smarty [Zamac]

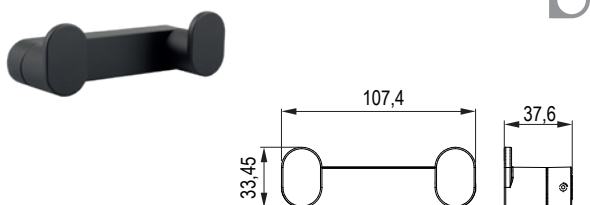

čierna matná

541301

Jonathan [Zamac]

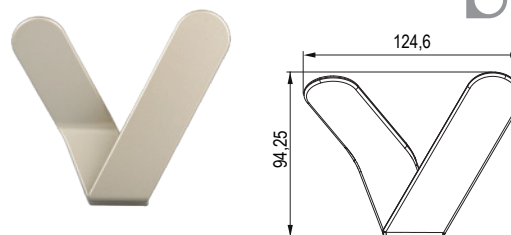

titanium

541302



čierna matná

541303

Aramis S [Zamac]

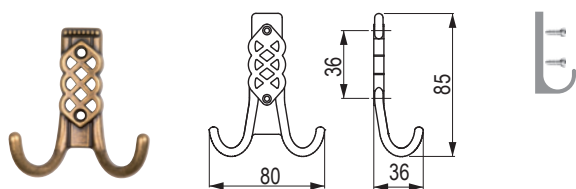

bronz

284271

Aramis M [Zamac]

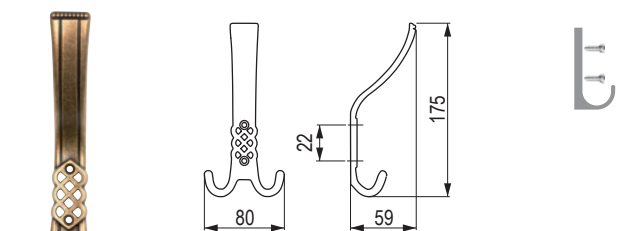

bronz

284273

Profily Floridy

- Možnosť rôznych kombinácií hotového profilu a skrátenej z 3 m profilu na mieru.
- Skrátenej profil je možné ukončiť 3 typmi koncoviek.
- Profil sa môže používať vertikálne aj horizontálne.
- Kombinácia profilov pre dverka na závesy aj pre dverka s výsuvom.

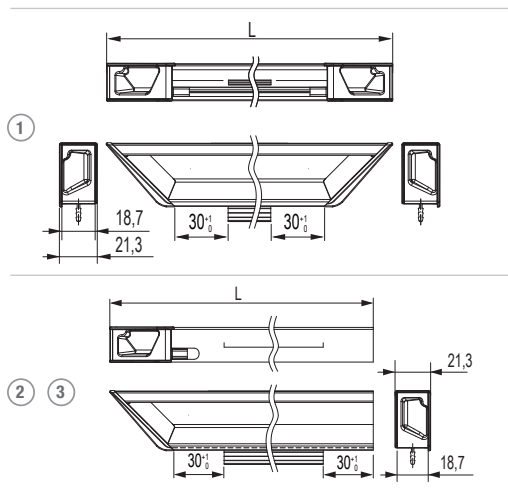
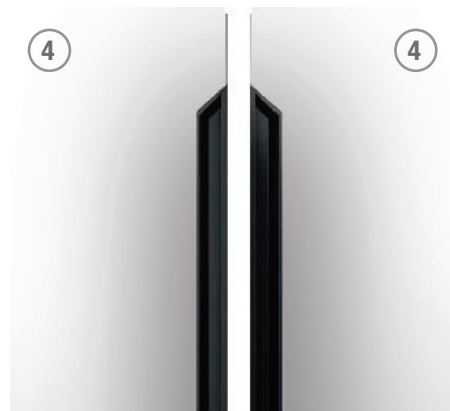

	●	čierna matná	dĺžka L (mm)	variant	hrúbka dverok (mm)	výška (mm)
1	●	541319	380	stredová	18	36
2	●	541323	200	ľavá	18	36
	●	541324	380	ľavá	18	36
3	●	541320	200	pravá	18	36
	●	541321	380	pravá	18	36
4	●	541325	1088	ľavá	18	36
	●	541322	1088	pravá	18	36



Profil Florida

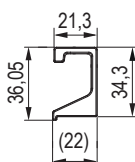

čierna matná	dĺžka L (mm)	hrúbka dvierok (mm)	výška (mm)
541326	3000	18	36

Koncovky k profilu Florida

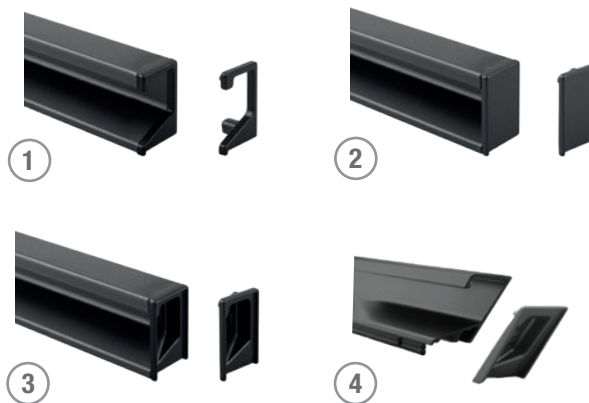

čierna matná	variant
1	541327 otvorená koncovka P+L
2	541328 uzavretá koncovka P+L
2	541329 stredová koncovka P+L
4	550784 stredová koncovka rovná



Anzio

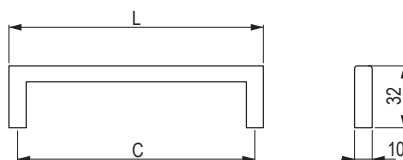

kód	kód Hettich	povrch	rozstup vrtania C (mm)	dĺžka L (mm)
133350	1160018	nehrdzavejúca oceľ brúsená	128	138
135134	1160020	nehrdzavejúca oceľ brúsená	224	234
146741	1160023	nehrdzavejúca oceľ brúsená	288	298
318716	9204177	nehrdzavejúca oceľ brúsená	320	330
133349	1160022	nehrdzavejúca oceľ brúsená	352	362
146742	1160023	nehrdzavejúca oceľ brúsená	480	490

Bermeo

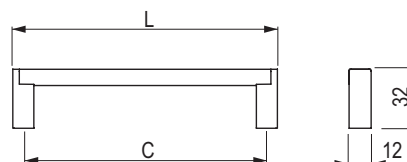

kód	kód Hettich	povrch	rozstup vrtania C (mm)	dĺžka L (mm)
395157	9208083	čierna matná/imitácia nehrdzavejúcej ocele	160	173
395156	9208087	čierna matná/imitácia nehrdzavejúcej ocele	288	301

Intra

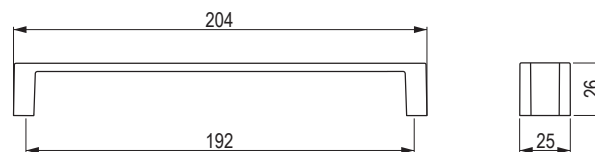

kód	kód Hettich	povrch
153731	9105735	imitácia nehrdzavejúcej ocele/chróm lesklý
134824	9105737	chróm matný/chróm lesklý

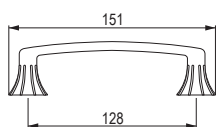
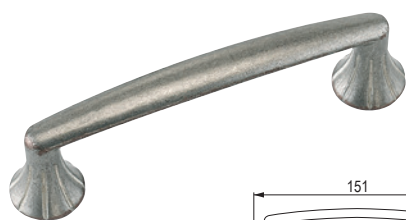
Salacia

kód	kód Hettich	povrch
135768	9112591	cín

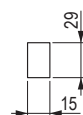
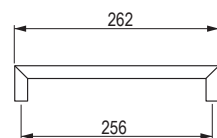
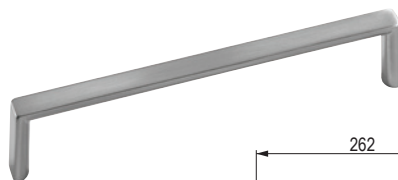
Baldone

kód	kód Hettich	povrch
135846	9995485	imitácia nehrdzavejúcej ocele

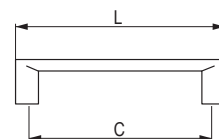
Chalcis

kód	kód Hettich	povrch	rozstup vrtania C (mm)	dĺžka L (mm)
161149	9113183	imitácia nehrdzavejúcej ocele	128	147
154385	9113182	imitácia nehrdzavejúcej ocele	288	301

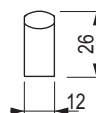
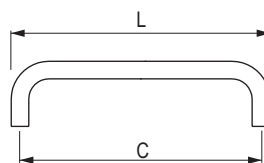
Naila

kód	kód Hettich	povrch	rozstup vrtania C (mm)	dĺžka L (mm)
409634	9266078	čierna matná	96	103
409635	9266079	čierna matná	128	135
409636	9266080	čierna matná	160	167
409637	9266091	čierna matná	192	199
409638	9266092	čierna matná	256	263
409640	9266094	čierna matná	320	327

Catana

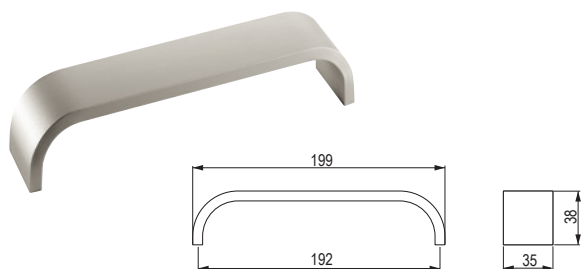

kód	kód Hettich	povrch
106317	115080	imitácia nehrdzavejúcej ocele

Vantania

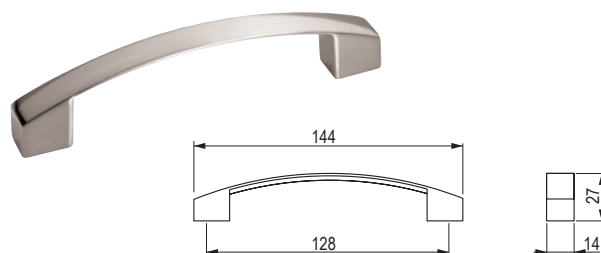

kód	kód Hettich	povrch
134885	1170158	imitácia nehrdzavejúcej ocele
153735	9113211	chróm lesklý

Salona

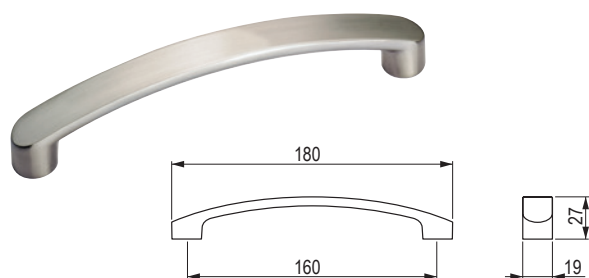

kód	kód Hettich	povrch
141597	1170155	imitácia nehrdzavejúcej ocele

Egara

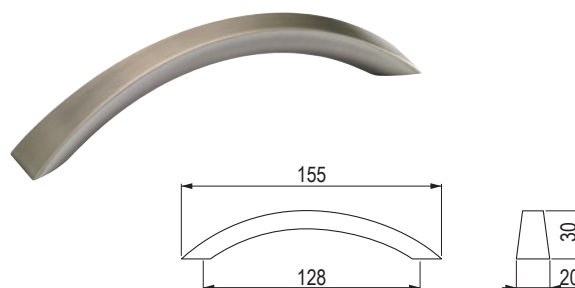

kód	kód Hettich	povrch
106184	9071719	starozlatá
106258	9071720	cín brúsený

Balmo

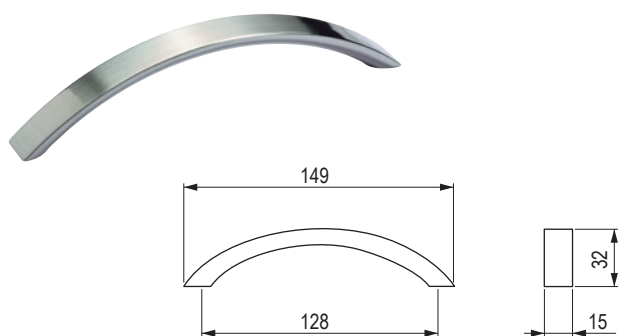

kód	kód Hettich	povrch
107814	43472	imitácia nehrdzavejúcej ocele

Genoa

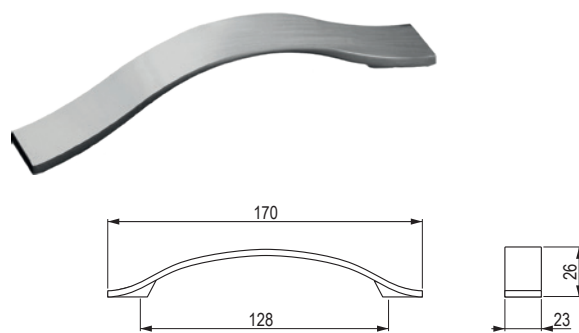

kód	kód Hettich	povrch
106675	9065612	imitácia nehrdzavejúcej ocele

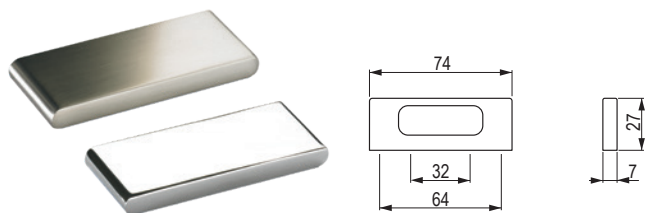
Fermo

kód	kód Hettich	povrch
107413	115020	chróm lesklý
106987	115019	imitácia nehrdzavejúcej ocele

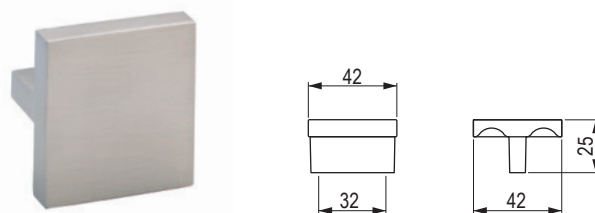
Messana

kód	kód Hettich	povrch
107020	115156	imitácia nehrdzavejúcej ocele

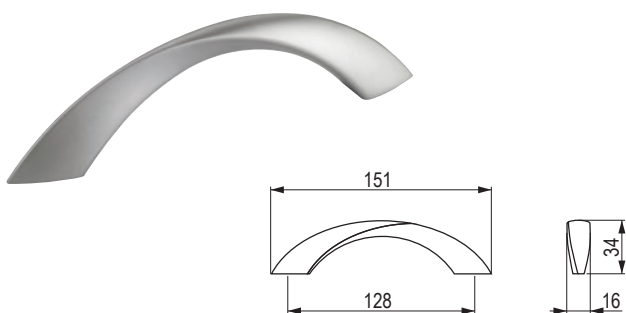
Coria

kód	kód Hettich	povrch
154567	9112597	chróm matný

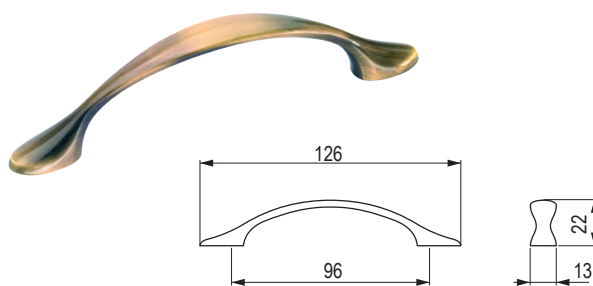
Haida

kód	kód Hettich	povrch
156856	9113227	starozlatá

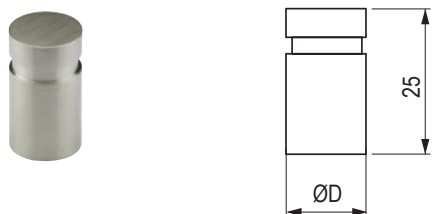
Monacum

kód	kód Hettich	povrch	priemer D (mm)
106762	9070957	nehrdzavejúca oceľ brúsená	10
106562	9070958	nehrdzavejúca oceľ brúsená	14

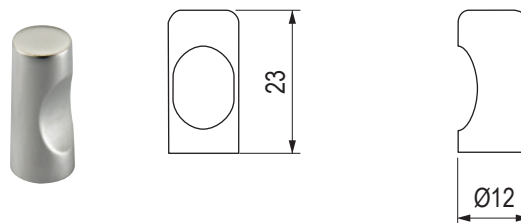
Almus

kód	kód Hettich	povrch
106827	9112583	chróm lesklý
105387	9112588	nikel matný
153736	9114036	imitácia nehrdzavejúcej ocele

Gela

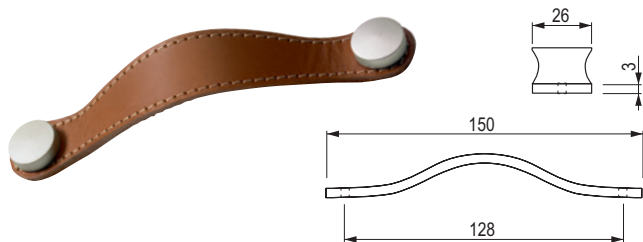

kód	kód Hettich	povrch
182316	9113645	svetlohnedá
131687	9113646	tmavohnedá
187687	9113647	čierna

Galati

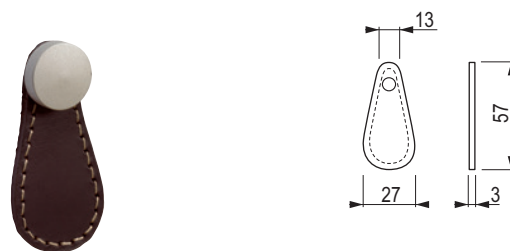

kód	kód Hettich	povrch
409643	9113645	svetlohnedá
409644	9113646	tmavohnedá

Príchytky pre úchytky Gela a Galati



kód	kód Hettich	povrch
376385	9113651	chróm matný
187690	9113653	nikel matný
187691	9113654	starobronz

Aboa

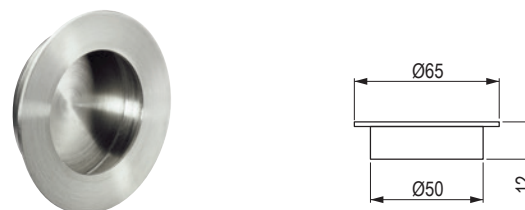

kód	kód Hettich	povrch
106763	9070138	nehrdzavejúca oceľ brúsená

Empoli

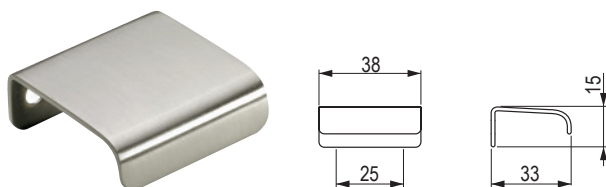

kód	kód Hettich	povrch
131685	9995541	chróm lesklý
133474	9995540	chróm matný
142100	9995542	imitácia nehrdzavejúcej ocele

Narni

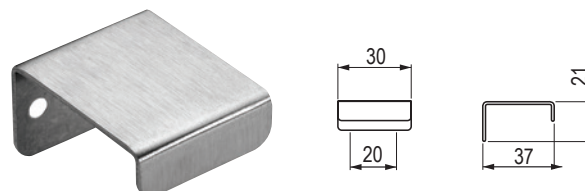

kód	kód Hettich	povrch
134538	9995574	nehrdzavejúca oceľ brúsená

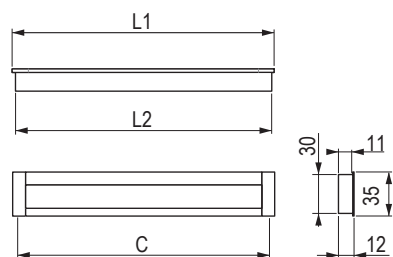
Nidum

kód	kód Hettich	povrch	rozstup vrtania C (mm)	dĺžka L1 (mm)	dĺžka L2 (mm)
106761	9071060	eloxovaný hliník	96	111	107
105388	9071071	eloxovaný hliník	128	143	139
107319	9071073	eloxovaný hliník	160	175	171
106090	9071075	eloxovaný hliník	192	207	203

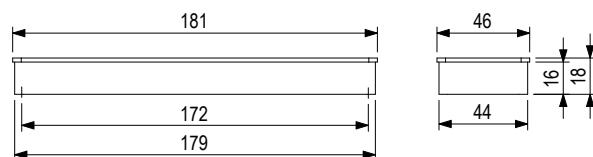
Touch - in

kód	kód Hettich	povrch
105901	9086687	imitácia nehrdzavejúcej ocele

Touch - in

kód	kód Hettich	popis	povrch
130326	9086695	krytka	plast nelakovaný
127861	9086696	krytka	imitácia nehrdzavejúcej ocele
106193	9086691	úchytka	imitácia nehrdzavejúcej ocele

- krytka bez povrchovej úpravy (plast ABS) je určená na nalakovanie
- krytka s povrchovou úpravou na nalepenie dyhy alebo podobného materiálu

Adaptér na pripevnenie úchytiak na roztváracie dvere

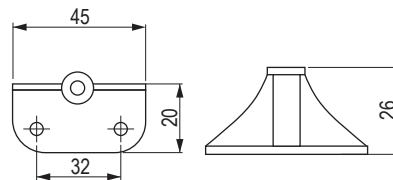

chróm

289675

satín nikel

289676

Gumová podložka úchytky na montáž do skla



gumová podložka úchytky

08002

- pre správnu funkciu použite 2 ks podložky na jednu skrutku
- kov nesmie priamo doliehať na sklo
- transparentná, pre priemer skrutky 4 mm

Označovacia šablóna BlueJig pre úchytky

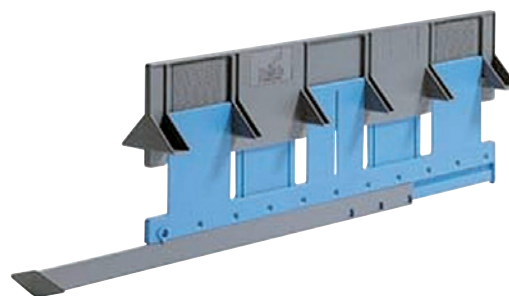

označovacie šablóny

104215

- univerzálna šablóna BLUEJIG s nastavením v dvoch osiach na rýchle a presné označenie polohy otvorov
- určené pre úchytky v rozstupe 32 – 320 (mm)
- rozsah vzdialeností od bočnej hrany čela zásuvky po prvý montážny otvor úchytky 10 – 334 (mm)
- rozsah vzdialeností od hornej hrany čela resp. od dolnej hrany čela po úchytku 20 – 65 (mm)

Šablóna na vŕtanie úchytiak Tulip

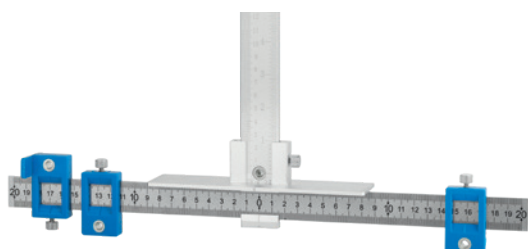

šablóna

495129

- šablóna Tulip na označenie polohy otvorov pre úchytky (vertikálna a horizontálna)
- nastavenie v dvoch osiach
- pre úchytky od 16 mm do 480 mm
- materiál: hliník, plast

TULIP

**Úchytka, ktorá rozkvitne
v každom interiéri**

